



## Wind 150 T

Extract fans

- Maximum airflow: 295
- Sound pressure level LpA at 3 m: 41
- Motor type: AC
- Casing material: Plastic
- Timer: Turn off timer

	Unit of measurement	Wind 150 T
Connected air duct size	mm	150
Speed	-	1
Minimum supply voltage	V	220
Maximum supply voltage	V	240
Power supply frequency	Hz	50
Rated power	W	26
Unit current	A	0.13
Maximum airflow	m <sup>3</sup> /h	295
Sound pressure level LpA at 3 m	dB(A)	41
Ingress protection rating	-	IP24

### Dimensions

a	b	e	c	D
210	195	66	60	150

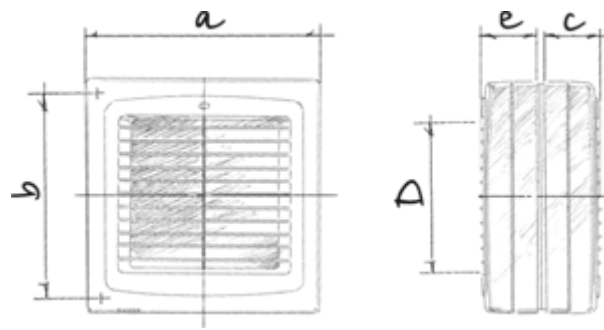

## Ecodesign

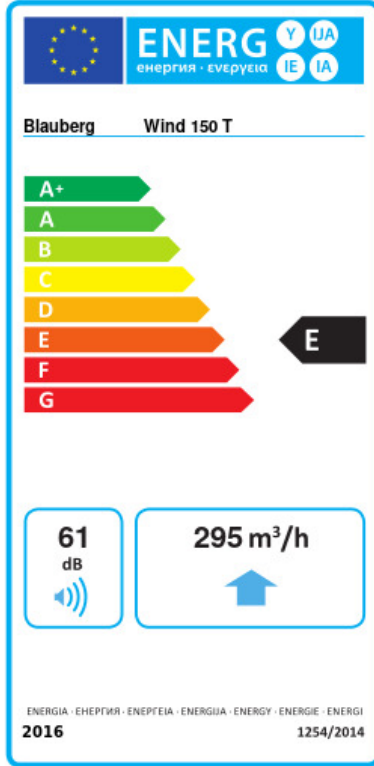

Trademark	Blaubeerg					
Model	Wind 150 T					
Specific energy consumption (SEC) (kWh/(m <sup>2</sup> /a))	Cold	Average	Warm			
	-28.9	B	-13.9	E	-5.3	F
Type of ventilation unit	Unidirectional					
Type of drive installed	Multi-speed					
Type of heat recovery system	None					
Maximum flow rate (m <sup>3</sup> /h)	295					
Electric power input (W)	26					
Reference flow rate (m <sup>3</sup> /s)	0.057					
Specific power input (SPI) (W/(m <sup>3</sup> /h))	0.057					
Control typology	Clock control					
Maximum external leakage rates (%)	2.7					
Airflow sensitivity at +20 Pa and -20 Pa (%)	0.15					
The indoor/outdoor air tightness (m <sup>3</sup> /h)	1					
Declared typology	RVU UVU					
Sound power level (dB(A))	61					
The annual electricity consumption (AEC) (kWh/a)	Cold	Average	Warm			
	74	74	74			
The annual heating saved (AHS) (kWh/a)	Cold	Average	Warm			
	3075	1572	711			