

# VENTO inHome mini W

Brand new dMVHR solutions for newbuild and retrofit single-room applications, offer efficient and cost-effective ventilation



- Air flow in heat recovery mode: 13
- Sound pressure level LpA at 3 m: 23
- Sound pressure level LpA at 1 m: 33
- Sound insulation
- Motor type: DC
- Enthalpy heat exchanger
- Control: Smartphone
- Humidity sensor
- Shutters

	Unit of measurement	VENTO inHome mini W		
Connected air duct size	mm	100		
Speed	-	3		
Phases	-	1		
Minimum supply voltage	V	100		
Maximum supply voltage	V	240		
Power supply frequency	Hz	50/60		
Rated power	W	1.0	1.6	3.0
Unit current	A	0.02	0.03	0.04
Air flow in ventilation mode	m <sup>3</sup> /h	8	16	25
Air flow in heat recovery mode	m <sup>3</sup> /h	4	8	13
Sound pressure level LpA at 3 m	dB(A)	10	16	23
Sound pressure level LpA at 1 m	dB(A)	20	26	33
Heat recovery efficiency, max	%	81		
Heat exchanger material	-	Ceramic		
Transported air temperature (max)	°C	40		
Transported air temperature (min)	°C	-15		
Ambient air temperature min	°C	1		
Ambient air temperature max	°C	40		
Ambient air humidity max	%	65		
Ingress protection rating	-	IP24		

## Dimensions

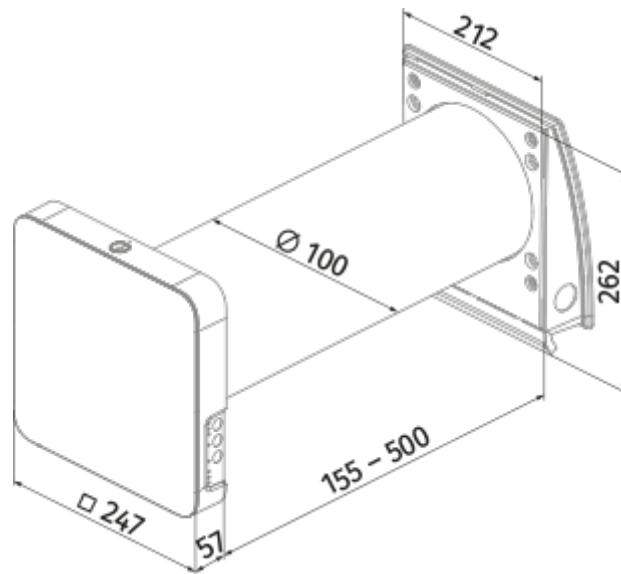

## Ecodesign

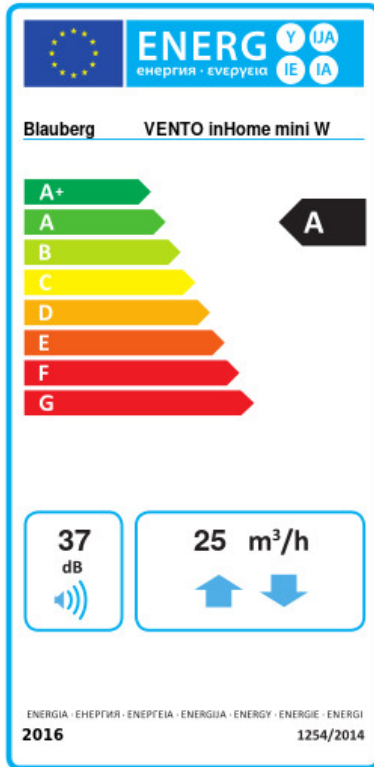











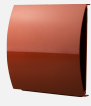



Trademark	Blauberg		
Model	VENTO inHome mini W		
Specific energy consumption (SEC) (kWh/(m <sup>2</sup> /a))	Cold	Average	Warm
	-81.5 A+	-40.9 A	-17.7 E
Type of ventilation unit	Bidirectional		
Type of drive installed	Variable speed		
Type of heat recovery system	Regenerative		
Thermal efficiency of heat recovery (%)	71		
Maximum flow rate (m <sup>3</sup> /h)	25		
Electric power input (W)	3		
Reference flow rate (m <sup>3</sup> /s)	0.004		
Specific power input (SPI) (W/(m <sup>3</sup> /h))	0.1		
Control typology	Local demand control		
Maximum internal leakage rates (%)	2.7		
Mixing rate (%)	1		
Sound power level (dB(A))	37		
Declared typology	RVU BVU		
The annual electricity consumption (AEC) (kWh/a)	Cold	Average	Warm
	190	190	190
The annual heating saved (AHS) (kWh/a)	Cold	Average	Warm
	8294	4240	1917





## Accessories

### Hoods

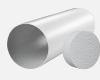

Name	Photo	Description
<a href="#">AH-10 beige 100</a>		Plastic hoods decoration of supply and exhaust vents of public, residential and industrial ventilation systems
<a href="#">AH-10 black 100</a>		Plastic hoods decoration of supply and exhaust vents of public, residential and industrial ventilation systems
<a href="#">AH-10 brown 100</a>		Plastic hoods decoration of supply and exhaust vents of public, residential and industrial ventilation systems

<a href="#">AH-10 chrome 100</a>		Plastic hoods decoration of supply and exhaust vents of public, residential and industrial ventilation systems
<a href="#">AH-10 grey 100</a>		Plastic hoods decoration of supply and exhaust vents of public, residential and industrial ventilation systems
<a href="#">AH-10 terracotta 100</a>		Plastic hoods decoration of supply and exhaust vents of public, residential and industrial ventilation systems
<a href="#">AH-10 white 100</a>		Plastic hoods decoration of supply and exhaust vents of public, residential and industrial ventilation systems
<a href="#">AH-11 vintage 100</a>		Plastic hoods decoration of supply and exhaust vents of public, residential and industrial ventilation systems
<a href="#">AH-11 black 100</a>		Plastic hoods decoration of supply and exhaust vents of public, residential and industrial ventilation systems
<a href="#">AH-11 grey 100</a>		Plastic hoods decoration of supply and exhaust vents of public, residential and industrial ventilation systems
<a href="#">AH-11 terracotta 100</a>		Plastic hoods decoration of supply and exhaust vents of public, residential and industrial ventilation systems
<a href="#">AH-11 white 100</a>		Plastic hoods decoration of supply and exhaust vents of public, residential and industrial ventilation systems
AH-S white 100		Stainless steel ventilation hood
AH-S chrome 100		Stainless steel ventilation hood
<a href="#">AH-8 white 100</a>		Outer ventilation hood with frost protection for a cold climate
<a href="#">AH-8 chrome 100</a>		Outer ventilation hood with frost protection for a cold climate
<a href="#">AH-11 anthracite grey 100</a>		Plastic hoods decoration of supply and exhaust vents of public, residential and industrial ventilation systems





### Other accessories

Name	Photo	Description
KIT BlauPlast white 100		Kit for angular mounting (for walls with standard thickness)
KIT BlauPlast chrome 100		Kit for angular mounting (for walls with standard thickness)
FP3 Vento G3		G3 filter kit (2 pcs.)
R 100-500		Air duct 100 mm and polystyrene foam plug
R 100-700		Air duct 100 mm and polystyrene foam plug

#### Other accessories

Name	Photo	Description
<a href="#">CD-1</a>		CO2 sensors
<a href="#">CD-2</a>		CO2 sensors

#### Other accessories

Name	Photo	Description
<a href="#">Pre-installation Kit Vento inHome mini</a>		Pre-installation kit for mounting into walls with standard thickness. Includes: air duct, AH-11 white 160 outer ventilation hood, polystyrene foam plug, polystyrene foam wedges
<a href="#">Pre-installation Kit Vento inHome mini S</a>		Pre-installation kit for mounting into thin walls. Includes: air duct, AH-S chrome 160 outer ventilation hood, polystyrene foam plug, polystyrene foam wedges
<a href="#">Completion Kit Vento inHome mini</a>		Final mounting kit. Includes: regenerator module, fan module, G3 filters (2 pcs.), indoor unit with a controller and shutters, remote control
<a href="#">FB Vento Expert A50</a>		Remote control