



VENTO Expert DUO A30-1 S10 W V.2

Single-room heat recovery units with Wi-Fi control

- Maximum airflow: 30
- Sound pressure level LpA at 3 m: 34
- Sound pressure level LpA at 1 m: 43
- Heat exchanger type: Reversible
- Motor type: EC
- Enthalpy heat exchanger
- Control: Smartphone
- Humidity sensor: Built-in
- CO2 sensor: Optional
- VOC sensor: Optional
- PM2.5 sensor: Optional
- Temperature sensor: Optional
- Shutters

	Unit of measurement	VENTO Expert DUO A30-1 S10 W V.2		
Connected air duct size	mm	160		
Speed	-	3		
Phases	-	1		
Minimum supply voltage	V	100		
Maximum supply voltage	V	240		
Power supply frequency	Hz	50/60		
Rated power	W	2.17	3.66	6.62
Unit current	A	0.026	0.039	0.066
Maximum airflow	m ³ /h	10	20	30
Sound pressure level LpA at 3 m	dB(A)	24	31	34
Sound pressure level LpA at 1 m	dB(A)	33	40	43
Heat recovery efficiency, max	%	85		
Heat exchanger type	-	Reversible		
Heat exchanger material	-	Ceramic		
Transported air temperature (max)	°C	40		
Transported air temperature (min)	°C	-15		
Ambient air temperature min	°C	1		
Ambient air temperature max	°C	40		
Ambient air humidity max	%	80		

Ingress protection rating	-	IP24
---------------------------	---	------

Dimensions

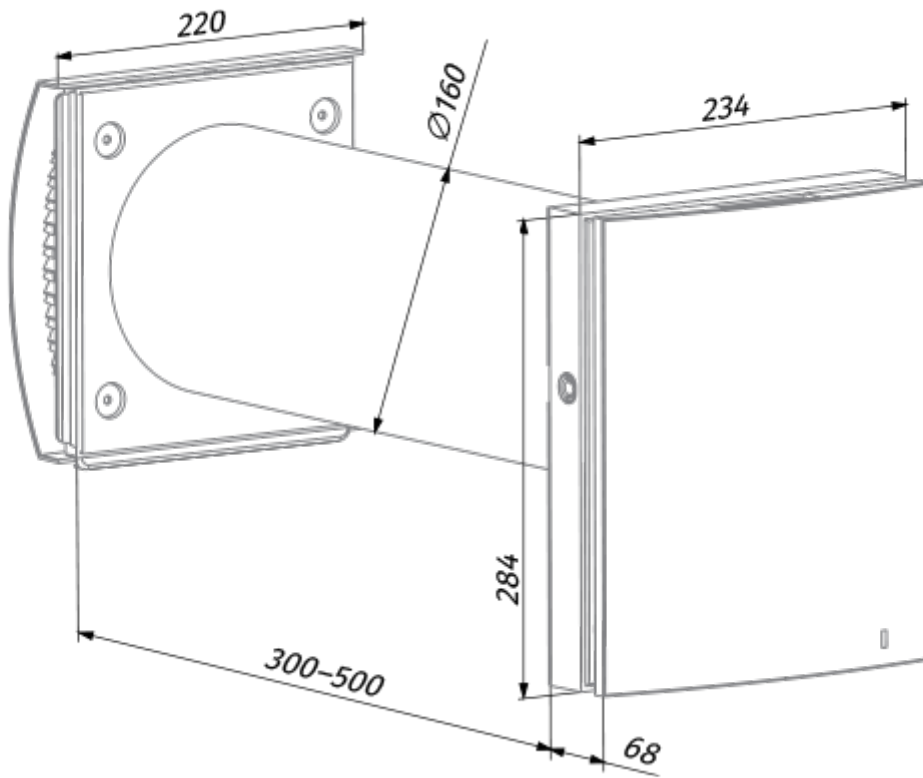

Ecodesign

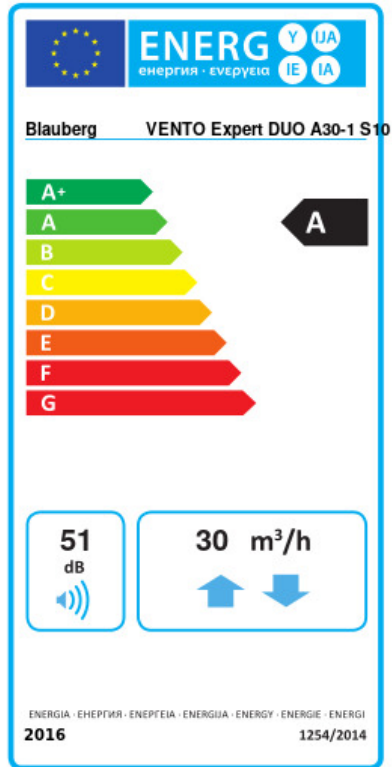

Trademark	Blauberg					
Model	VENTO Expert DUO A30-1 S10 W V.2					
Specific energy consumption (SEC) (kWh/(m ² /a))	Cold		Average		Warm	
	-81.6	A+	-40.4	A	-16.8	E
Type of ventilation unit	Bidirectional					
Type of drive installed	Variable speed					
Type of heat recovery system	Regenerative					
Thermal efficiency of heat recovery (%)	74					
Maximum flow rate (m ³ /h)	30					
Electric power input (W)	6.6					
Reference flow rate (m ³ /s)	0.006					
Specific power input (SPI) (W/(m ³ /h))	0.183					
Control typology	Local demand control					
Maximum internal leakage rates (%)	2.7					
Mixing rate (%)	1					
Airflow sensitivity at +20 Pa and -20 Pa (%)	0.37					
The indoor/outdoor air tightness (m ³ /h)	5.2					
Declared typology	RVU BVU					
Sound power level (dB(A))	51					
The annual electricity consumption (AEC) (kWh/a)	Cold		Average		Warm	
	107		107		107	

Accessories

Hoods

Name	Photo	Description
PP 160/0.5		The outer hood is designed to prevent the ingress of water and large objects into the ventilation equipment from outside

Other accessories

Name	Photo	Description
------	-------	-------------

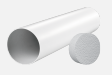
R 160-500		Air duct 160 mm and polystyrene foam plug
R 160-700		Air duct 160 mm and polystyrene foam plug
S Vento Expert A30		



Other accessories

Name	Photo	Description
SE Vento Expert W		Control panel

Other accessories

Name	Photo	Description
FB Vento Expert A50		Remote control

Other accessories

Name	Photo	Description
CD-1		CO2 sensors
CD-2		CO2 sensors