

# Reneo SE 270-E R S21

Heat and energy recovery air handling units



- Power of electrical preheater: 1400
- Maximum airflow: 331
- Sound pressure level LpA at 3 m: 34
- Heat exchanger type: Counter flow
- Extract filter: G4 / Coarse > 60%
- Supply filter: G4 / Coarse > 60% (option: F7 / ePM1 60%)
- Sound insulation
- Motor type: EC
- Enthalpy heat exchanger
- Bypass: Auto
- Reheater: Optional
- Preheater: Built-in
- BMS protocol: ModBus
- Control: Smartphone
- Casing material: EPP
- Humidity sensor: Optional
- CO2 sensor: Optional
- VOC sensor: Optional
- PM2.5 sensor: Optional

	Unit of measurement	Reneo SE 270-E R S21
Connected air duct size	mm	125
Phases	-	1
Minimum supply voltage	V	230
Maximum supply voltage	V	230
Power supply frequency	Hz	50/60
Rated power	W	182
Power of electrical preheater	W	1400
Unit current	A	7.61
Maximum airflow	m <sup>3</sup> /h	331
Sound pressure level LpA at 3 m	dB(A)	34
Heat recovery efficiency, max	%	83
Heat exchanger type	-	Counter flow
Heat exchanger material	-	Enthalpy
Weight	kg	24
Extract filter	-	G4 / Coarse > 60%
Supply filter	-	G4 / Coarse > 60% (option: F7 / ePM1 60%)
Transported air temperature (max)	°C	40
Transported air temperature (min)	°C	-25

Ambient air temperature min	°C	1
Ambient air temperature max	°C	40
Ambient air humidity max	%	60
Ingress protection rating	-	IP22
Ingress protection rating of the drive	-	IP44

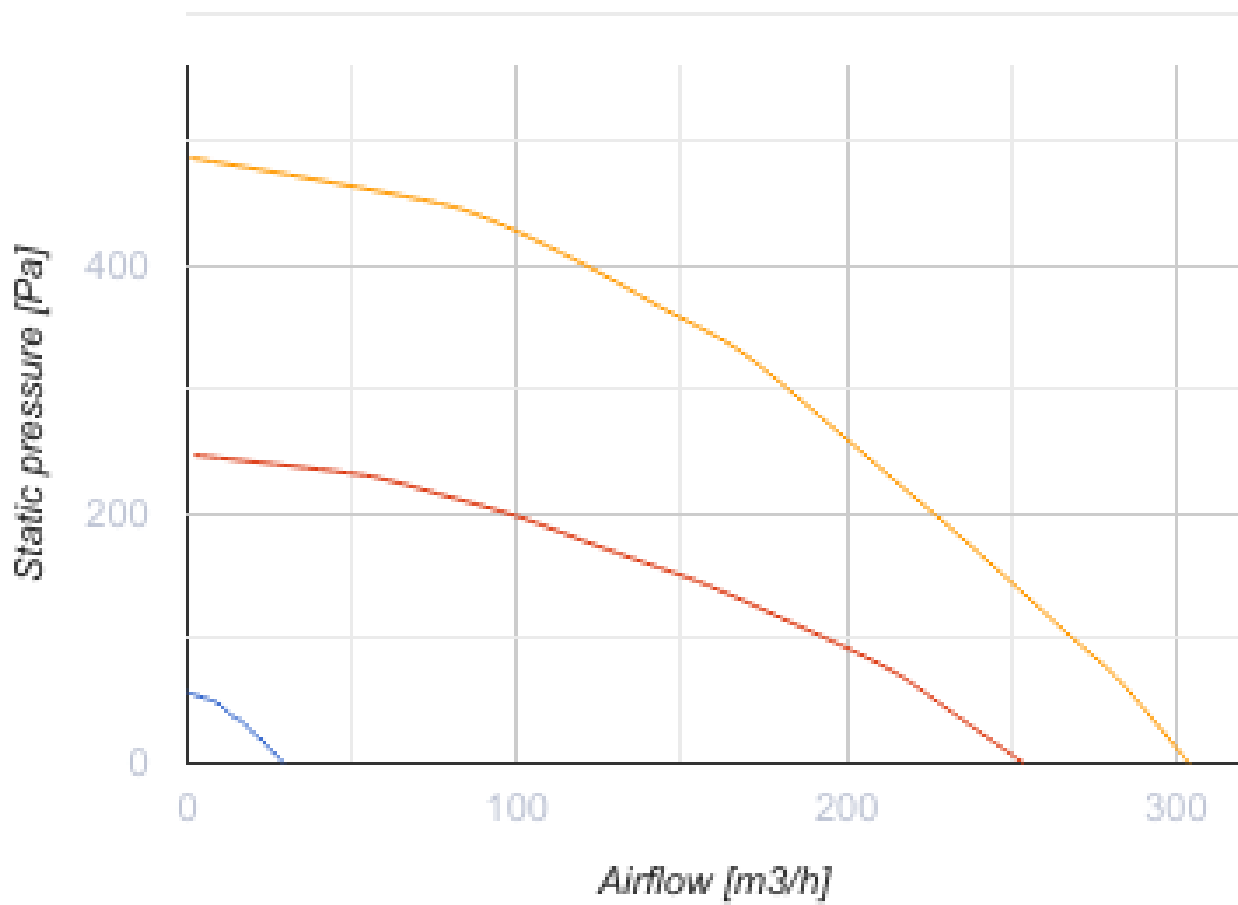

### Dimensions

D	H	H1	L	L1	W	W1
125	900	958	452	190	598	273

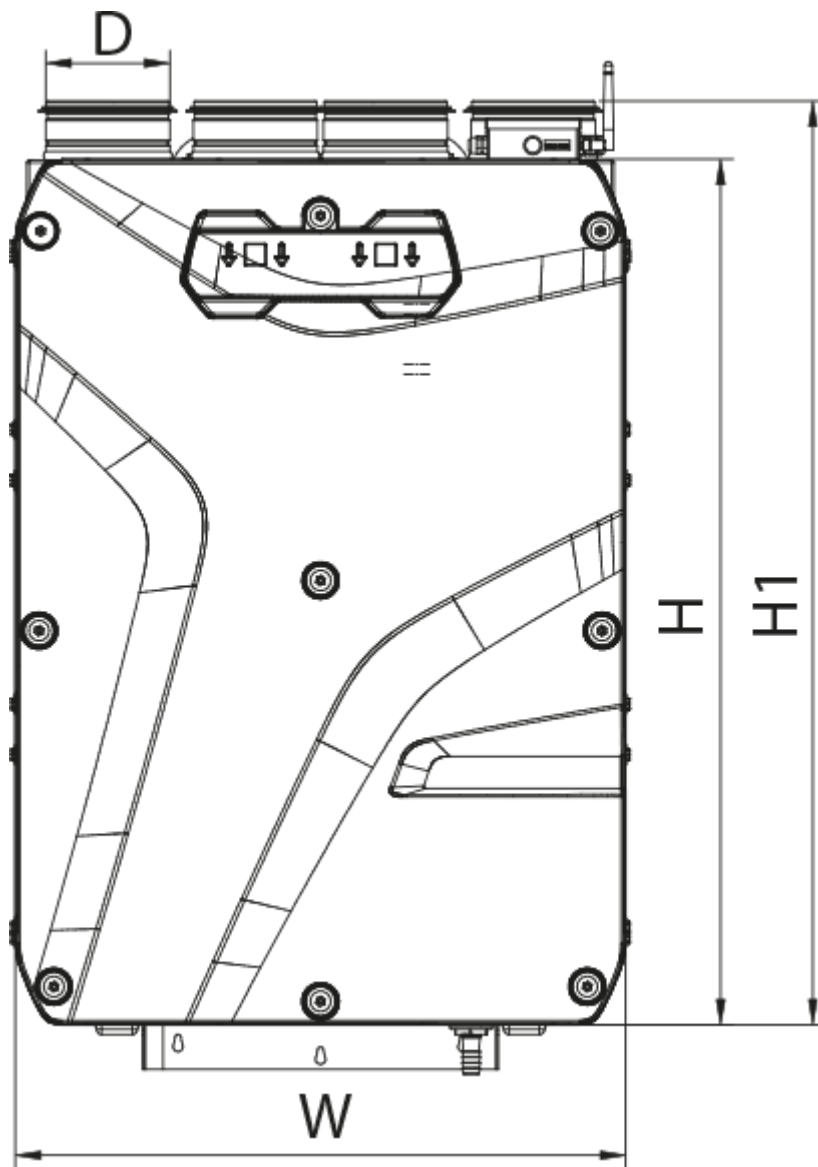

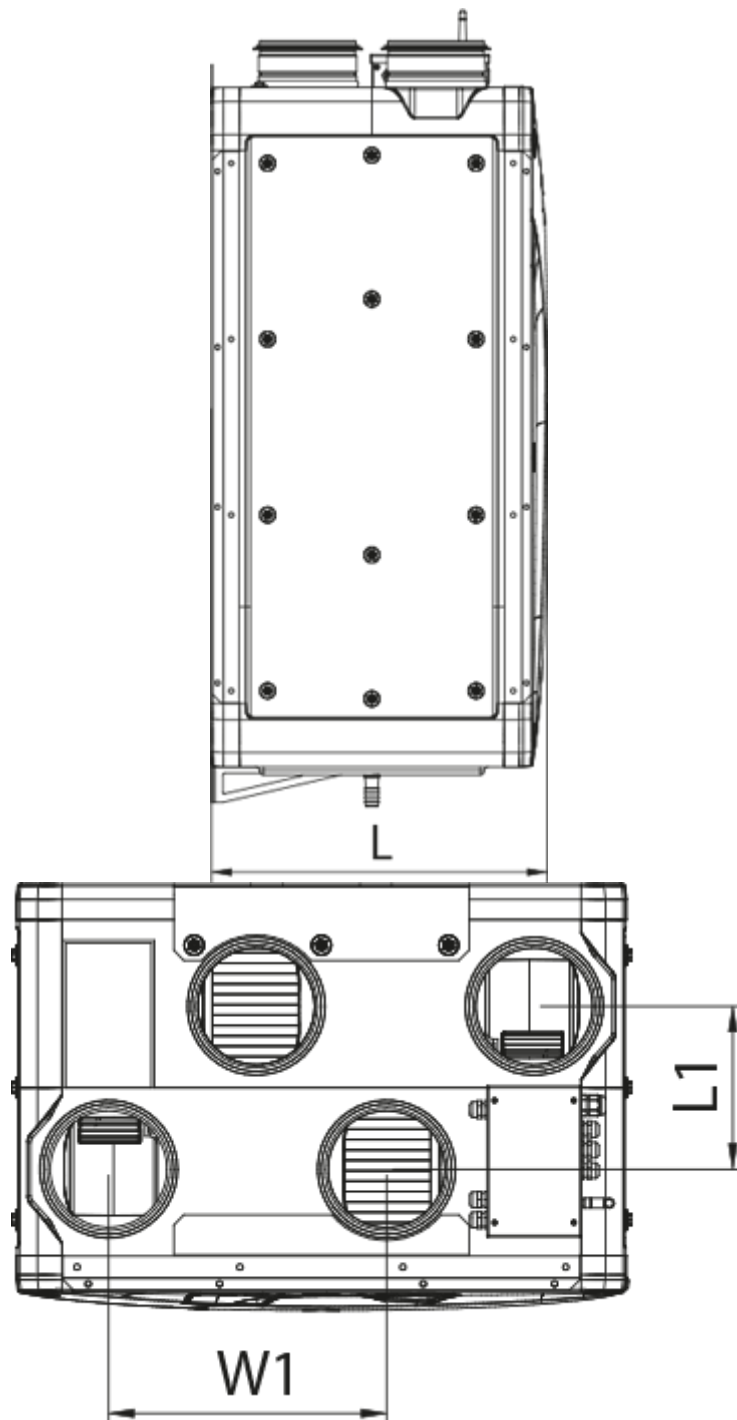





## Accessories

### Other accessories



Name	Photo	Description
------	-------	-------------

FP 356x100x48 Coarse 90% G4		G4 panel filter
FP 356x100x48 ePM1 60% F7		F7 panel filter

### Other accessories



Name	Photo	Description
<a href="#">S22</a>		Control panels
<a href="#">S22 Wi-Fi</a>		Control panels
<a href="#">S25</a>		LCD control panel

### Other accessories



Name	Photo	Description
<a href="#">FS2</a>		Humidity sensor
<a href="#">CD-1</a>		CO2 sensors
<a href="#">CD-2</a>		CO2 sensors
<a href="#">CD-3</a>		

### Other accessories

Name	Photo	Description
<a href="#">ENH 125-0.6-1 S21 V.2</a>		Duct heater for supply air reheating

<a href="#">ENH 125-0.8-1 S21 V.2</a>		Duct heater for supply air reheating
<a href="#">ENH 125-1.2-1 S21 V.2</a>		Duct heater for supply air reheating

### Other accessories

Name	Photo	Description
<a href="#">SD 125/600</a>		Silencers for round ducts
<a href="#">SD 125/900</a>		Silencers for round ducts
<a href="#">SD 125/1200</a>		Silencers for round ducts

### Other accessories

Name	Photo	Description
<a href="#">VKA 125</a>		Air dampers for round ducts