



Reneo S 550-E R S21

Heat and energy recovery air handling units

- Maximum airflow: 660
- Sound pressure level LpA at 3 m: 57
- Heat exchanger type: Counter flow
- Extract filter: Coarse > 60 %
- Supply filter: Coarse > 60 % (option: ePM1 60 %)
- Sound insulation
- Motor type: EC
- Enthalpy heat exchanger
- Bypass: Auto
- Reheater: Optional
- Preheater: Optional
- BMS protocol: ModBus
- Control: Smartphone
- Casing material: EPP
- Humidity sensor: Optional
- CO2 sensor: Optional
- VOC sensor: Optional
- PM2.5 sensor: Optional

	Unit of measurement	Reneo S 550-E R S21
Connected air duct size	mm	200
Phases	-	1
Minimum supply voltage	V	230
Maximum supply voltage	V	230
Power supply frequency	Hz	50/60
Rated power	W	347
Unit current	A	2.4
Maximum airflow	m ³ /h	660
Sound pressure level LpA at 3 m	dB(A)	57
Heat recovery efficiency, max	%	80
Heat exchanger type	-	Counter flow
Heat exchanger material	-	Enthalpy
Weight	kg	28
Extract filter	-	Coarse > 60 %
Supply filter	-	Coarse > 60 % (option: ePM1 60 %)
Transported air temperature (max)	°C	40
Transported air temperature (min)	°C	-25
Ambient air temperature min	°C	1
Ambient air temperature max	°C	40

Ambient air humidity max	%	60
Ingress protection rating	-	IP22
Ingress protection rating of the drive	-	IP44

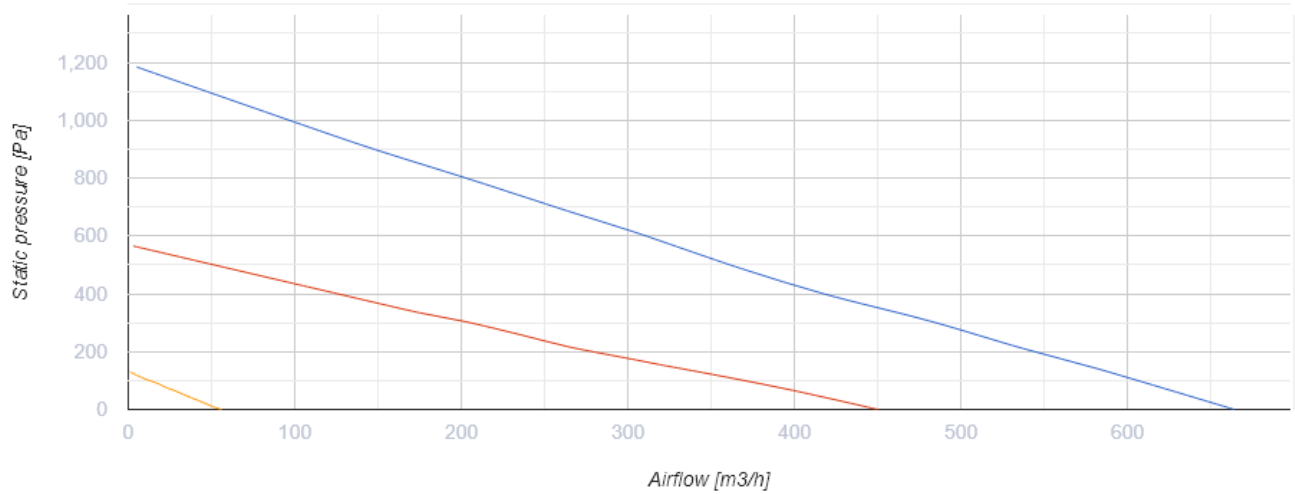

Dimensions

Ø D	H	H1	L	L1	W	W1
200	885	943	711	250	820	365

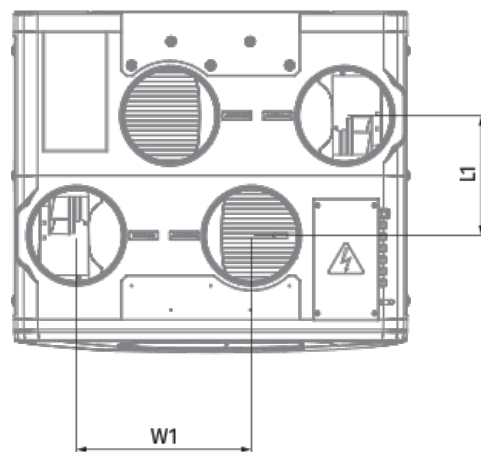
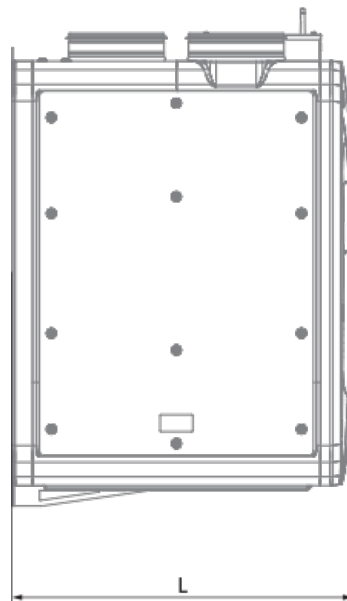
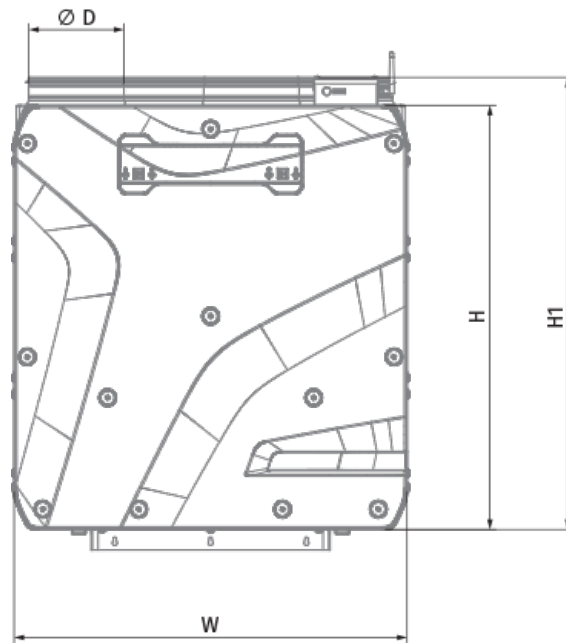



Accessories



Other accessories

Name	Photo	Description
FP 596x164x60 Coarse 90% G4		G4 panel filter
FP 596x164x60 ePM1 60% F7		F7 panel filter

Other accessories

Name	Photo	Description
S25		LCD control panel
S22		Control panels
S22 Wi-Fi		Control panels

Other accessories



Name	Photo	Description
FS2		Humidity sensor
CD-3		
CD-1		CO2 sensors
CD-2		CO2 sensors

Other accessories

Name	Photo	Description
------	-------	-------------

EVH 200-1.2-1 S21 V.2		Electric duct preheater for heat exchanger freeze protection
EVH 200-1.7-1 S21 V.2		Electric duct preheater for heat exchanger freeze protection
EVH 200-2.0-1 S21 V.2		Electric duct preheater for heat exchanger freeze protection
ENH 200-1.2-1 S21 V.2		Duct heater for supply air reheating
ENH 200-1.7-1 S21 V.2		Duct heater for supply air reheating
ENH 200-2.0-1 S21 V.2		Duct heater for supply air reheating

Other accessories

Name	Photo	Description
SD 200/600		Silencers for round ducts
SD 200/900		Silencers for round ducts
SD 200/1200		Silencers for round ducts

Other accessories

Name	Photo	Description
VKA 200		Air dampers for round ducts