



Reneo S 351 R S14

Heat and energy recovery air handling units

- Maximum airflow: 410
- Sound pressure level LpA at 3 m: 26
- Heat exchanger type: Counter flow
- Extract filter: Coarse > 60 %
- Supply filter: Coarse > 60 % (option: ePM1 60 %)
- Sound insulation
- Motor type: EC
- Bypass: Manual
- Control: Wired control panel
- Casing material: EPP
- Humidity sensor: Optional
- CO2 sensor: Optional

| | Unit of measurement | Reneo S 351 R S14 |
|-----------------------------------|---------------------|-----------------------------------|
| Connected air duct size | mm | 160 |
| Speed | - | 1 |
| Phases | - | 1 |
| Minimum supply voltage | V | 230 |
| Maximum supply voltage | V | 230 |
| Power supply frequency | Hz | 50/60 |
| Rated power | W | 213 |
| Unit current | A | 1.62 |
| Maximum airflow | m ³ /h | 410 |
| Sound pressure level LpA at 3 m | dB(A) | 26 |
| Heat recovery efficiency, max | % | 93 |
| Heat exchanger type | - | Counter flow |
| Heat exchanger material | - | Polystyrene |
| Weight | kg | 26 |
| Extract filter | - | Coarse > 60 % |
| Supply filter | - | Coarse > 60 % (option: ePM1 60 %) |
| Transported air temperature (max) | °C | 40 |
| Transported air temperature (min) | °C | -25 |
| Ambient air temperature min | °C | 1 |
| Ambient air temperature max | °C | 40 |
| Ambient air humidity max | % | 60 |

| | | |
|--|---|------|
| Ingress protection rating | - | IP22 |
| Ingress protection rating of the drive | - | IP44 |

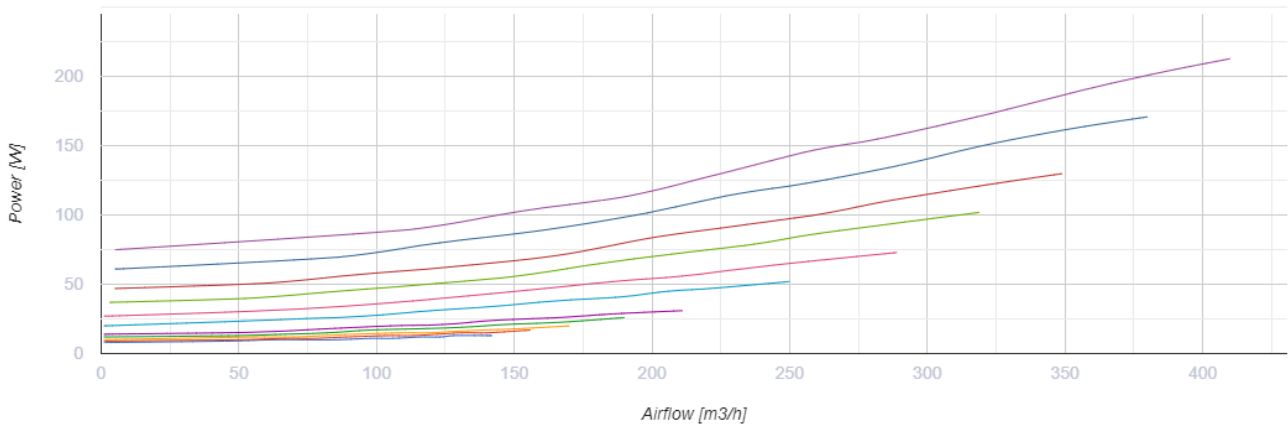
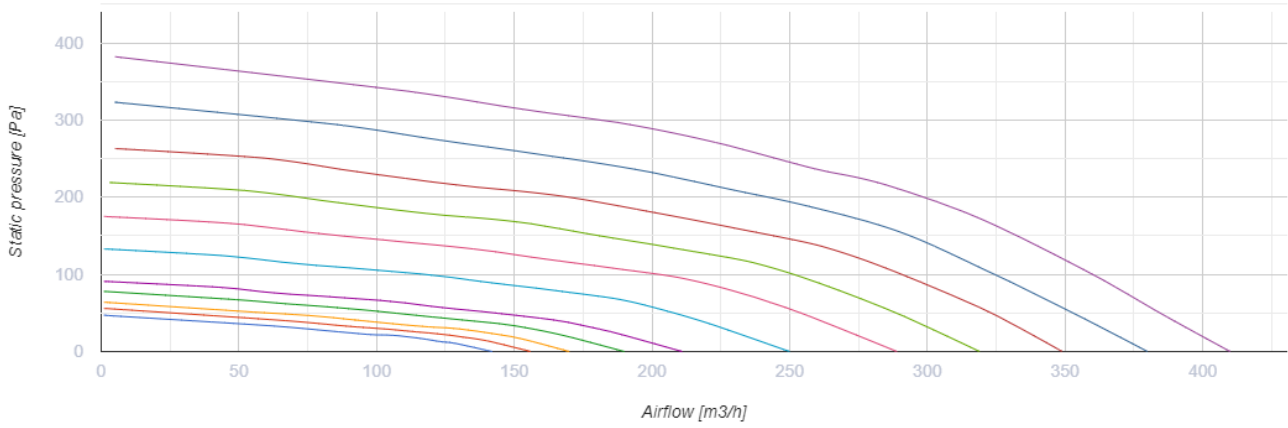

Dimensions

| Ø D | H | H1 | L | L1 | W | W1 |
|-----|-----|-----|-----|-----|-----|-----|
| 160 | 880 | 939 | 616 | 230 | 770 | 355 |

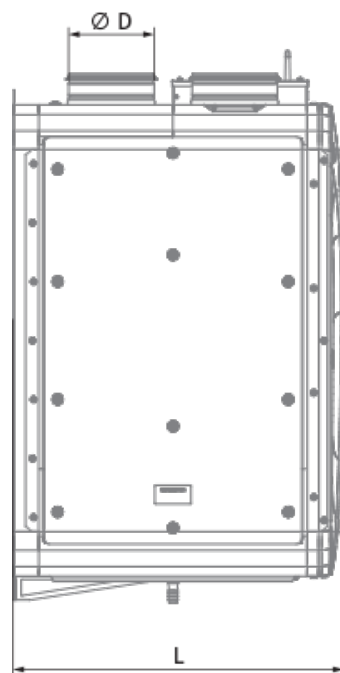
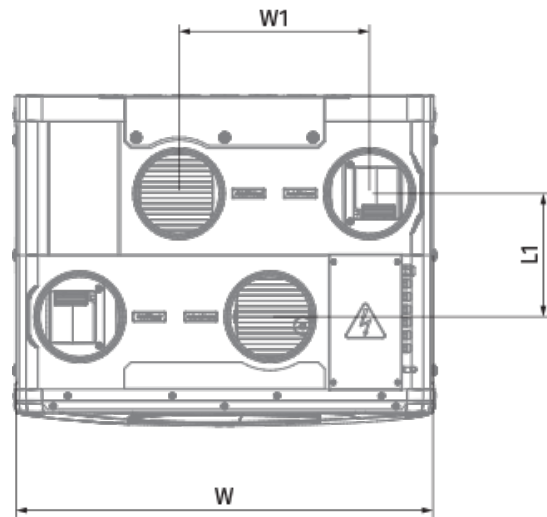
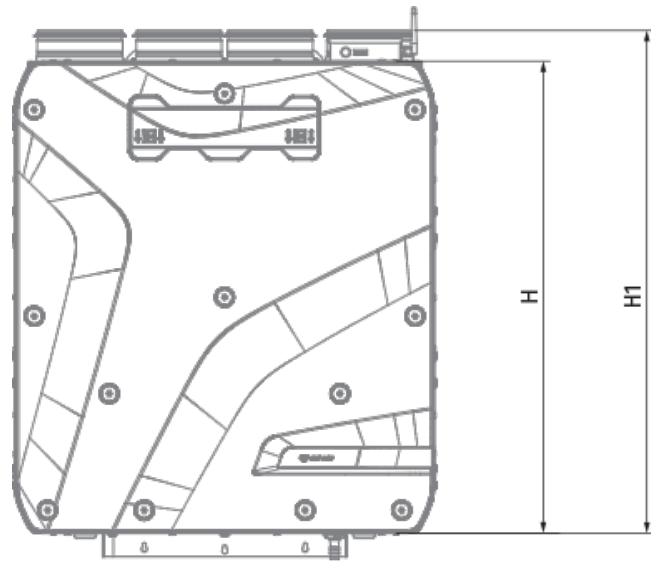

Ecodesign

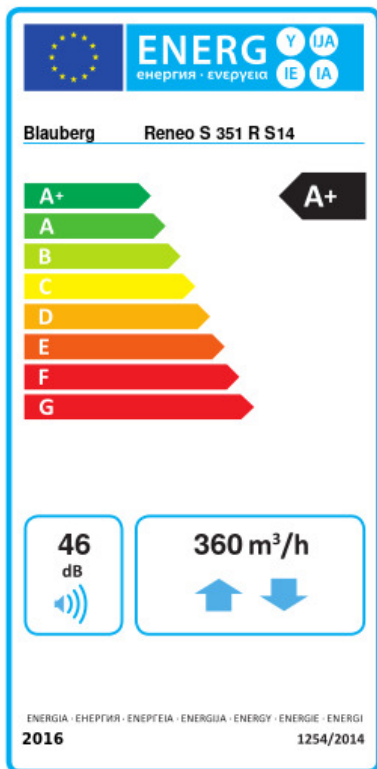

| | | | | | | |
|---|----------------------|----|---------|----|------|---|
| Trademark | Blauberg | | | | | |
| Model | Reneo S 351 R S14 | | | | | |
| Specific energy consumption (SEC) (kWh/(m ² /a)) | Cold | | Average | | Warm | |
| | 82.6 | A+ | 43 | A+ | 17.8 | E |
| Type of ventilation unit | Bidirectional | | | | | |
| Type of drive installed | Variable speed | | | | | |
| Type of heat recovery system | Recuperative | | | | | |
| Thermal efficiency of heat recovery (%) | 90 | | | | | |
| Maximum flow rate (m ³ /h) | 360 | | | | | |
| Electric power input (W) | 213 | | | | | |
| Reference flow rate (m ³ /s) | 0.071 | | | | | |
| Reference pressure difference (Pa) | 50 | | | | | |
| Specific power input (SPI) (W/(m ³ /h)) | 0.26 | | | | | |
| Control typology | Local demand control | | | | | |
| Maximum internal leakage rates (%) | 2.7 | | | | | |
| Maximum external leakage rates (%) | 2.7 | | | | | |
| Sound power level (dB(A)) | 46 | | | | | |
| Declared typology | RVU BVU | | | | | |
| The annual electricity consumption (AEC) (kWh/a) | Cold | | Average | | Warm | |
| | 720 | | 183 | | 138 | |
| The annual heating saved (AHS) (kWh/a) | Cold | | Average | | Warm | |
| | 9181 | | 4693 | | 2122 | |

Accessories

Other accessories



| Name | Photo | Description |
|-----------------------------|-------|-----------------|
| FP 496x150x60 Coarse 90% G4 | | G4 panel filter |

| | | |
|---------------------------|---|-----------------|
| FP 496x150x60 ePM1 65% F7 |  | F7 panel filter |
|---------------------------|---|-----------------|

Other accessories

| Name | Photo | Description |
|--------------------------------|---|------------------|
| EP-Reneo S 351 |  | Decorative panel |



Other accessories

| Name | Photo | Description |
|----------------------|---|-----------------|
| FS2 |  | Humidity sensor |
| CD-3 | | |
| CD-1 |  | CO2 sensors |
| CD-2 |  | CO2 sensors |

Other accessories

| Name | Photo | Description |
|---------------------------|---|--|
| SFK 20x32 |  | Hydraulic syphon for condensate drainage |

Other accessories

| Name | Photo | Description |
|----------------------------|---|---------------------------|
| SD 160/600 |  | Silencers for round ducts |
| SD 160/900 |  | Silencers for round ducts |

| | | |
|-----------------------------|---|---------------------------|
| SD 160/1200 |  | Silencers for round ducts |
|-----------------------------|---|---------------------------|

Other accessories

| Name | Photo | Description |
|-------------------------|---|-----------------------------|
| VKA 160 |  | Air dampers for round ducts |

Other accessories

| Name | Photo | Description |
|------------------------------|---|--------------------|
| Belimo TF230 |  | Electric actuators |