

# Reneo-Fit D 200 S21

Heat and energy recovery air handling units



- Maximum airflow: 279
- Sound pressure level LpA at 3 m: 33
- Heat exchanger type: Counter flow
- Extract filter: G4 / Coarse > 60%
- Supply filter: G4 / Coarse > 60% (option F7 / ePM1 60%)
- Sound insulation
- Motor type: EC
- Bypass: Auto
- Reheater: Optional
- Preheater: Optional
- BMS protocol: ModBus
- Control: Smartphone
- Casing material: EPP
- Humidity sensor: Optional
- CO2 sensor: Optional
- VOC sensor: Optional
- PM2.5 sensor: Optional

	Unit of measurement	Reneo-Fit D 200 S21
Connected air duct size	mm	160/125
Phases	-	1
Minimum supply voltage	V	230
Maximum supply voltage	V	230
Power supply frequency	Hz	50/60
Rated power	W	111
Unit current	A	0.9
Maximum airflow	m <sup>3</sup> /h	279
Sound pressure level LpA at 3 m	dB(A)	33
Heat recovery efficiency, max	%	89
Heat exchanger type	-	Counter flow
Heat exchanger material	-	Polystyrene
Weight	kg	18
Extract filter	-	G4 / Coarse > 60%
Supply filter	-	G4 / Coarse > 60% (option F7 / ePM1 60%)
Transported air temperature (max)	°C	45
Ambient air temperature min	°C	1
Ambient air temperature max	°C	40
Ambient air humidity max	%	60

Ingress protection rating	-	IP22
Ingress protection rating of the drive	-	IP44

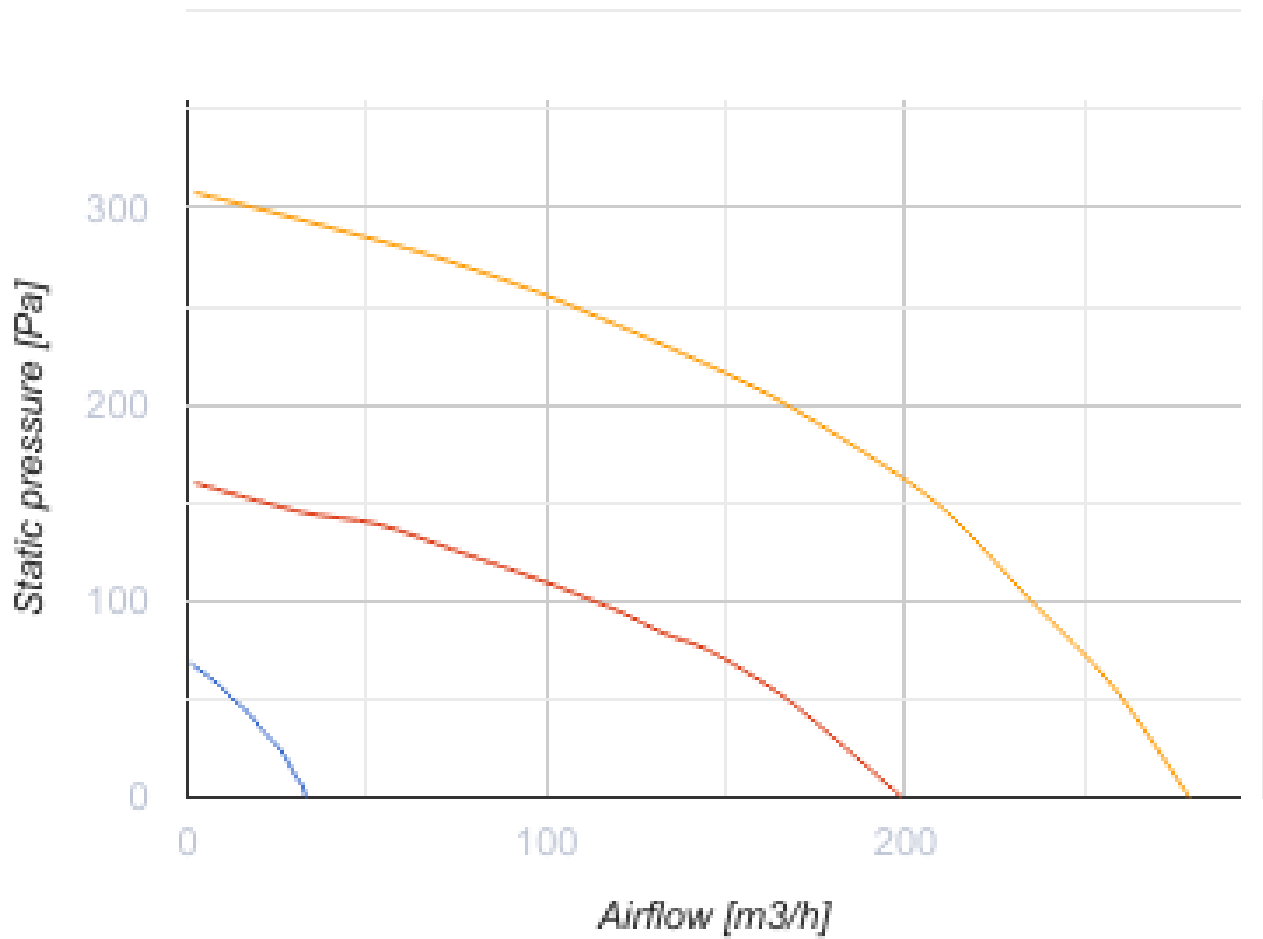

### Dimensions

Ø D	Ø D1	H	L	L1	W	W1	W2	W3
160	125	242	1160	685	683	642	610	521



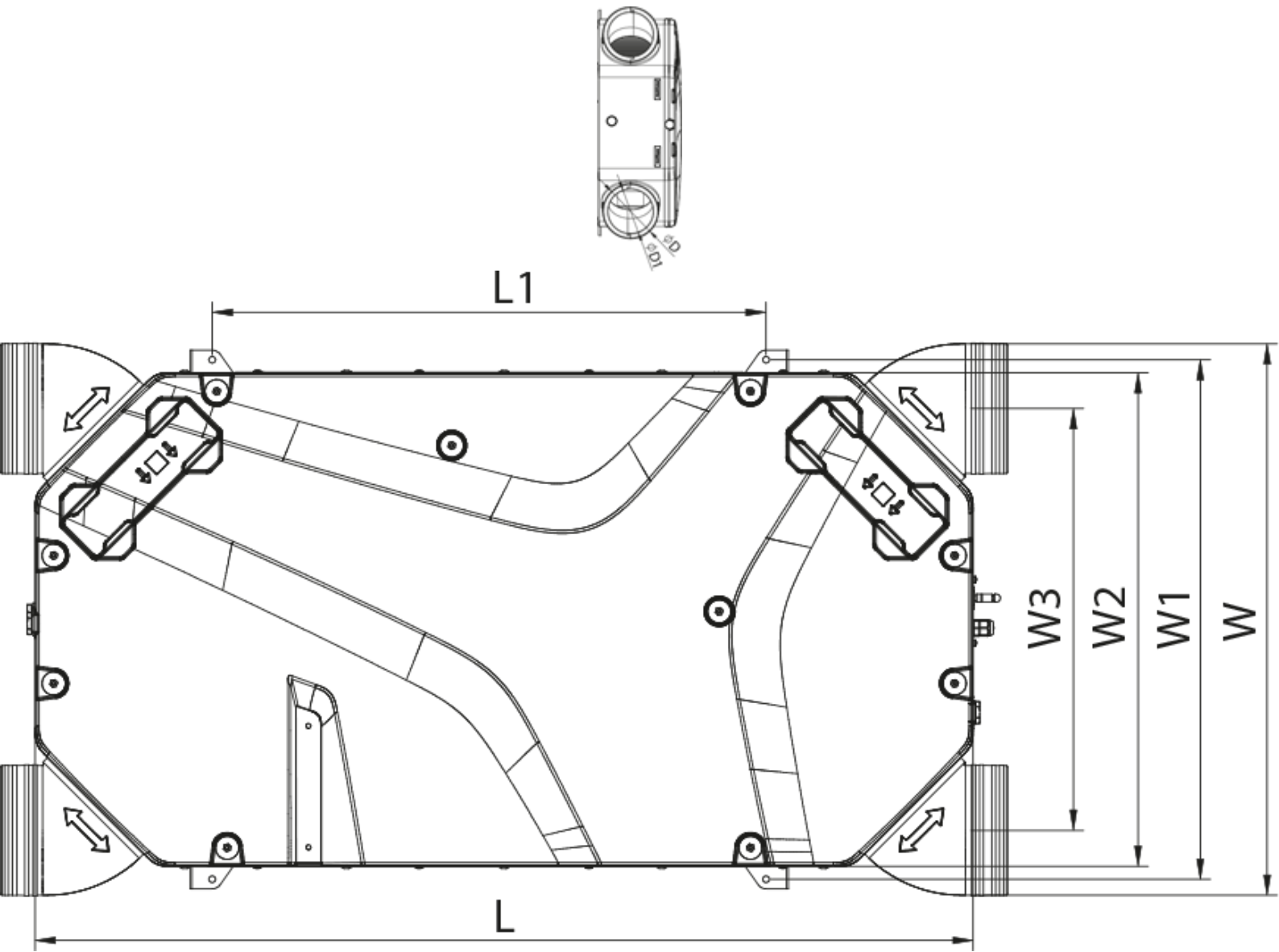





## Accessories

### Other accessories



Name	Photo	Description
FP 200x165x48 Coarse 90% G4		G4 panel filter

FP 200x165x48 ePM1 60% F7		F7 panel filter
---------------------------	---	-----------------



### Other accessories





Name	Photo	Description
<a href="#">S25</a>		LCD control panel
<a href="#">S22</a>		Control panels
<a href="#">S22 Wi-Fi</a>		Control panels

### Other accessories

Name	Photo	Description
<a href="#">FS2</a>		Humidity sensor
<a href="#">CD-3</a>		
<a href="#">CD-1</a>		CO2 sensors
<a href="#">CD-2</a>		CO2 sensors

### Other accessories



Name	Photo	Description
<a href="#">EVH 160-0.8-1 S21 V.2</a>		Electric duct preheater for heat exchanger freeze protection
<a href="#">EVH 160-1.2-1 S21 V.2</a>		Electric duct preheater for heat exchanger freeze protection
<a href="#">EVH 160-1.7-1 S21 V.2</a>		Electric duct preheater for heat exchanger freeze protection

<a href="#">EVH 160-2.0-1 S21 V.2</a>		Electric duct preheater for heat exchanger freeze protection
<a href="#">ENH 160-0.8-1 S21 V.2</a>		Duct heater for supply air reheating
<a href="#">ENH 160-1.2-1 S21 V.2</a>		Duct heater for supply air reheating
<a href="#">ENH 160-1.7-1 S21 V.2</a>		Duct heater for supply air reheating
<a href="#">ENH 160-2.0-1 S21 V.2</a>		Duct heater for supply air reheating

#### Other accessories

Name	Photo	Description
<a href="#">SFK 20x32</a>		Hydraulic syphon for condensate drainage

#### Other accessories

Name	Photo	Description
<a href="#">SD 160/600</a>		Silencers for round ducts
<a href="#">SD 160/900</a>		Silencers for round ducts
<a href="#">SD 160/1200</a>		Silencers for round ducts

#### Other accessories

Name	Photo	Description
<a href="#">VKA 160</a>		Air dampers for round ducts