



## Primo 160

Mixed-flow inline fans

- Maximum airflow: 600
- Sound pressure level LpA at 3 m: 37
- Motor type: AC
- Impeller type: Mixed-flow
- Casing material: Plastic
- Installation in any position

	Unit of measurement	Primo 160		
Connected air duct size	mm	160		
Speed	-	3		
Phases	-	1		
Minimum supply voltage	V	230		
Maximum supply voltage	V	230		
Power supply frequency	Hz	50		
Rated power	W	34	37	45
Unit current	A	0.15	0.16	0.20
Maximum airflow	m <sup>3</sup> /h	488	544	600
Sound pressure level LpA at 3 m	dB(A)	34	35	37
Weight	kg	2.9		
Transported air temperature (max)	°C	55		
Transported air temperature (min)	°C	-25		
Ingress protection rating	-	IPX4		
Ingress protection rating of the drive	-	IP20		

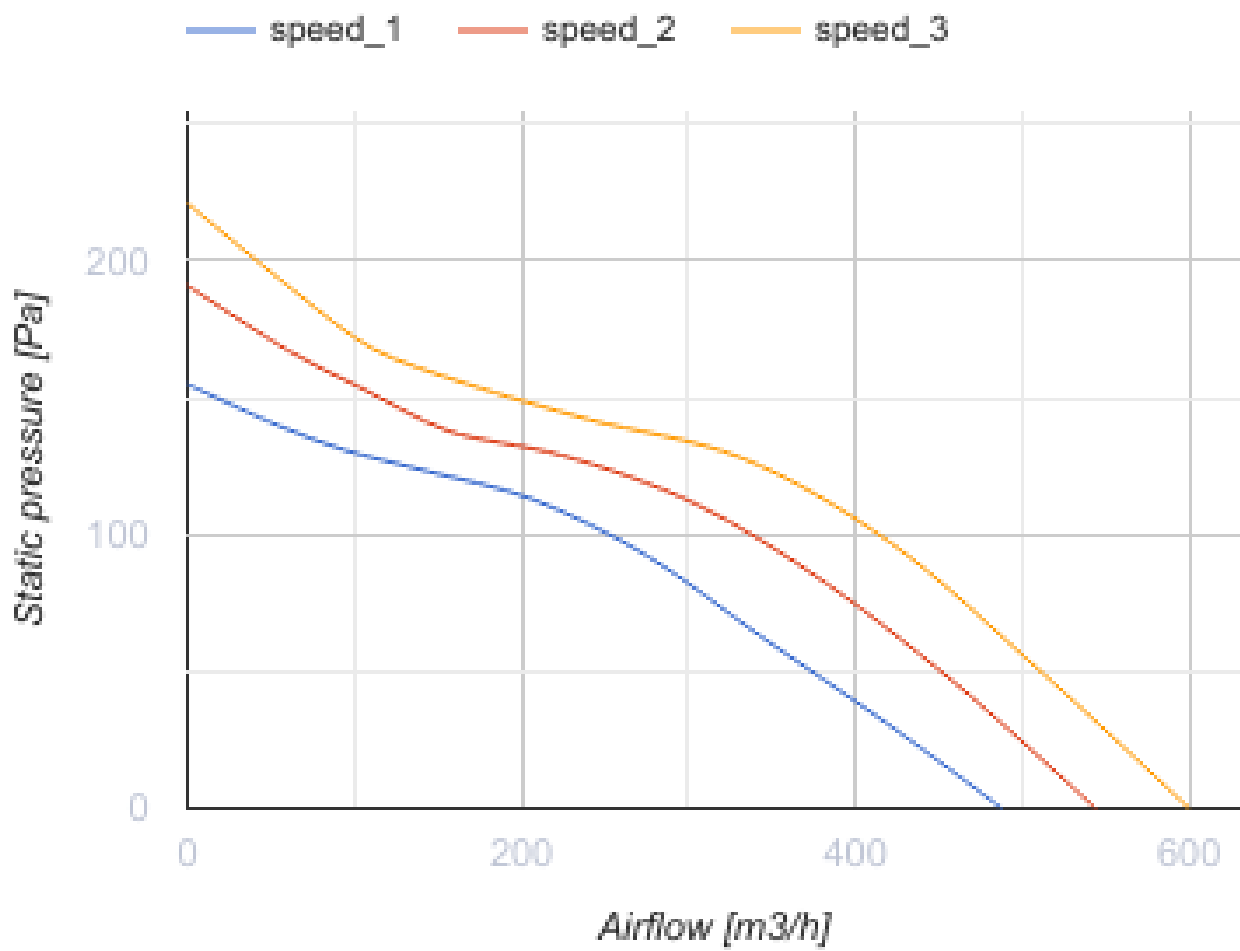
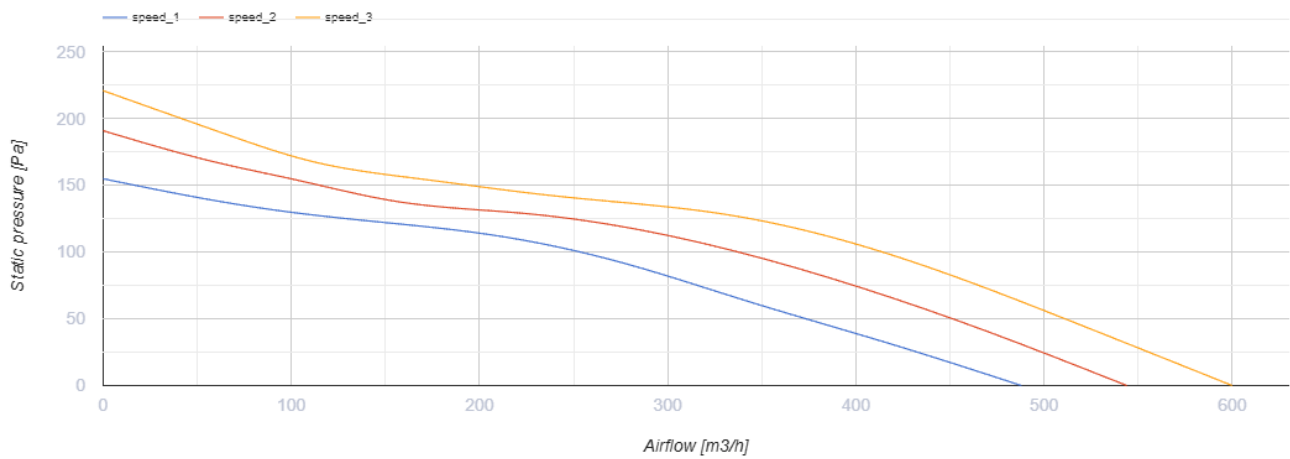

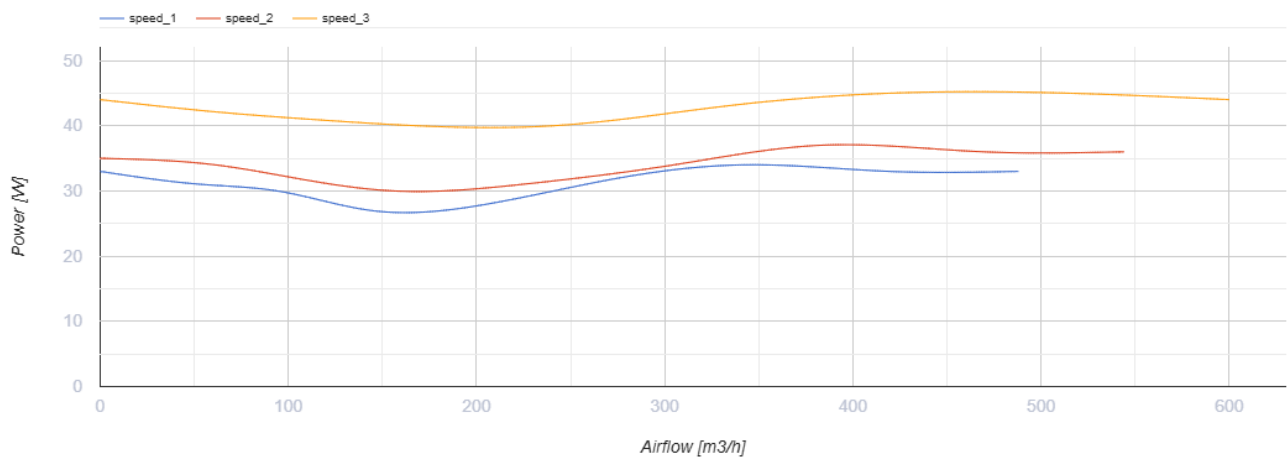
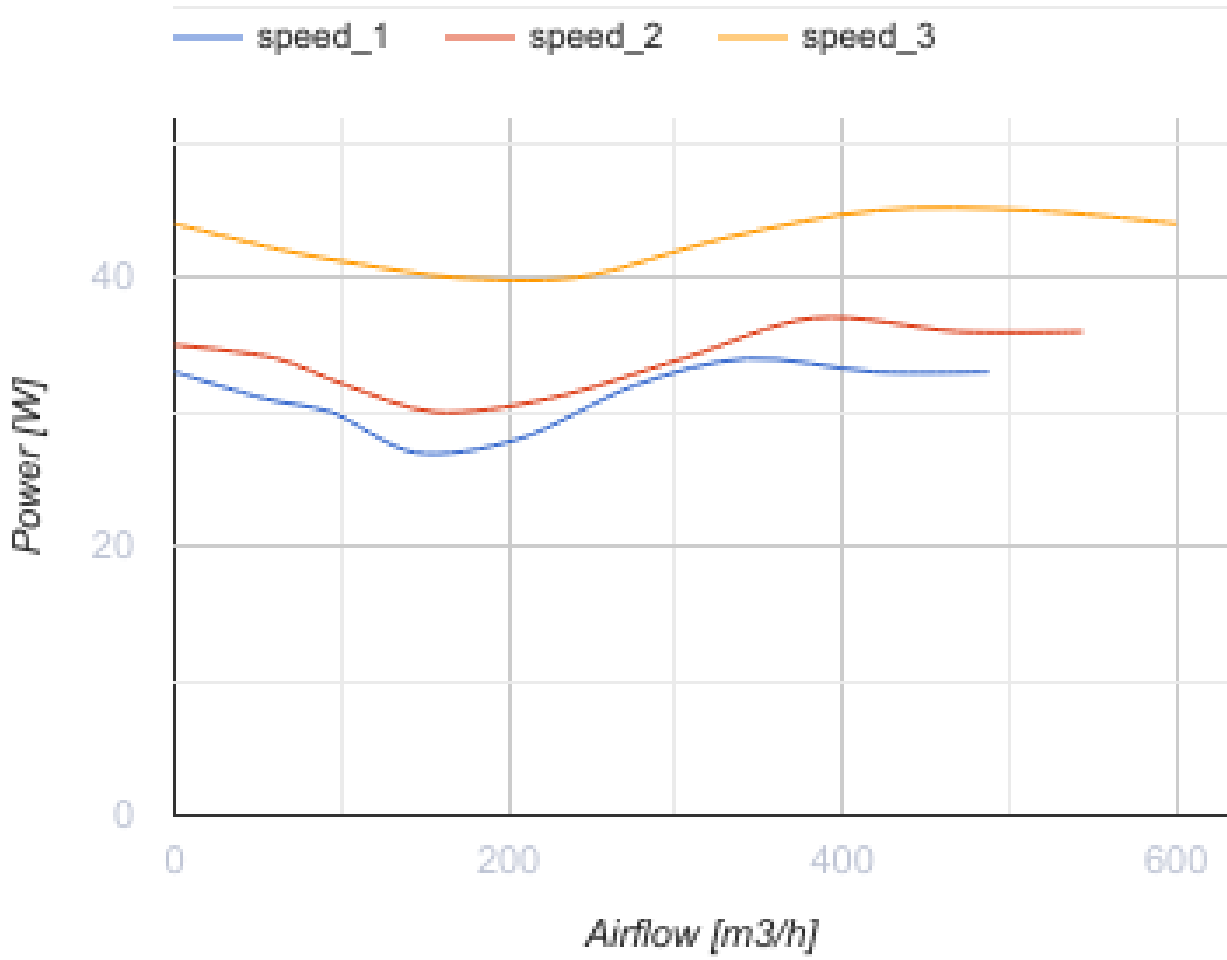

## Dimensions

A	B	C	Ø D
267	301	251	160

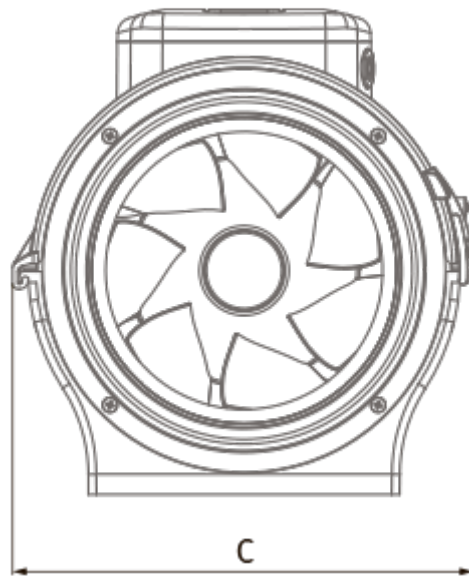
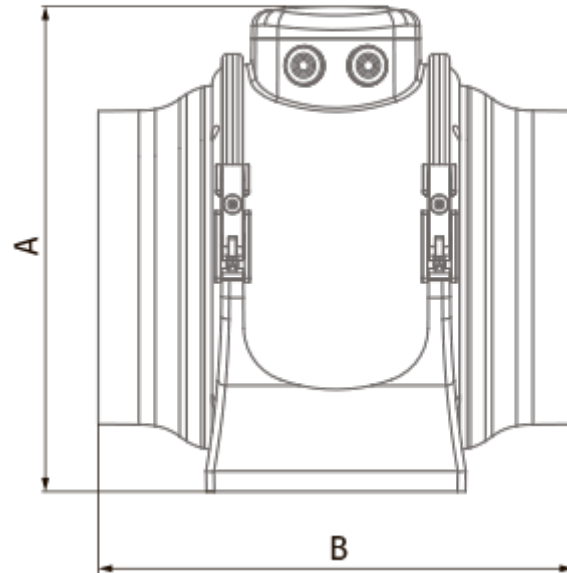

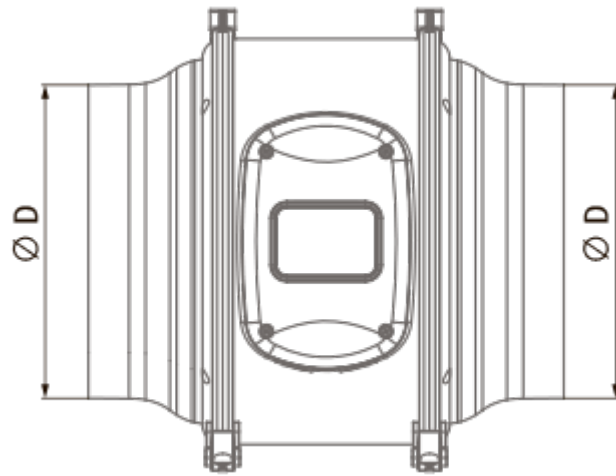



## Ecodesign



Trademark	Blauberg
Model	Primo 160
Type of ventilation unit	Unidirectional
Type of drive installed	Integrated VSD
Type of heat recovery system	None
Nominal flow rate (m <sup>3</sup> /s)	0.092
Nominal external pressure (Pa)	128
Maximum external leakage rates (%)	2.7
Static efficiency (%)	28
Declared typology	NRVU UVU
Effective electric power input (kW)	0.043
Sound power level (dB(A))	56



## Accessories

### Other accessories











Name	Photo	Description
<a href="#">SD 160/1200</a>		Silencers for round ducts
<a href="#">SD 160/900</a>		Silencers for round ducts
<a href="#">SD 160/600</a>		Silencers for round ducts

### Other accessories

Name	Photo	Description
<a href="#">KFBK 160</a>		Filter boxes for round ducts
<a href="#">KFBT 160 F7</a>		Filter boxes with pocket filters for round ducts



<a href="#">KFBT 160 F5</a>		Filter boxes with pocket filters for round ducts
<a href="#">KFBT 160 G4</a>		Filter boxes with pocket filters for round ducts

### Other accessories

Name	Photo	Description
<a href="#">EKH 160-6.0</a>		Duct electrical heaters for round ducts
<a href="#">EKH 160-5.1</a>		Duct electrical heaters for round ducts
<a href="#">EKH 160-3.6</a>		Duct electrical heaters for round ducts
<a href="#">EKH 160-3.4</a>		Duct electrical heaters for round ducts
<a href="#">EKH 160-2.4</a>		Duct electrical heaters for round ducts
<a href="#">EKH 160-2.0</a>		Duct electrical heaters for round ducts
<a href="#">EKH 160-1.7</a>		Duct electrical heaters for round ducts
<a href="#">EKH 160-1.2</a>		Duct electrical heaters for round ducts
<a href="#">WKH 160-4</a>		Duct water heaters for round ducts
<a href="#">WKH 160-2</a>		Duct water heaters for round ducts

### Other accessories





Name	Photo	Description
------	-------	-------------

<a href="#">VRV 160</a>		Backdraft dampers with spring for round ducts
<a href="#">VKA 160</a>		Air dampers for round ducts

### Air distribution

Name	Photo	Description
<a href="#">K 160</a>		Clamp for round flexible ducts

### Other accessories

Name	Photo	Description
<a href="#">CDP-3/5</a>		Multi-speed switch
<a href="#">CDTE E3.0 TP</a>		Speed controllers
<a href="#">CDT E1.8</a>		Thyristor speed controller
<a href="#">CDT1 E0.5</a>		Multi-speed switches

### Speed control switches

Name	Photo	Description
<a href="#">CDPE-3 E5</a>		