



KOMFORT Ultra EC L2 300-H S14 white

Compact heat recovery air handling units

- Maximum airflow: 300
- Sound pressure level LpA at 3 m: 33
- Heat exchanger type: Cross flow
- Extract filter: G4
- Supply filter: G4, F8
- Sound insulation
- Motor type: EC
- Control: Wired control panel
- Casing material: Double-skinned white painted metal panels
- CO2 sensor: Optional
- VOC sensor: Optional
- PM2.5 sensor: Optional

| | Unit of measurement | KOMFORT Ultra EC L2 300-H S14 white |
|-----------------------------------|---------------------|-------------------------------------|
| Connected air duct size | mm | 125 |
| Speed | - | 1 |
| Phases | - | 1 |
| Minimum supply voltage | V | 230 |
| Maximum supply voltage | V | 230 |
| Power supply frequency | Hz | 50/60 |
| Rated power | W | 165 |
| Unit current | A | 1.3 |
| Maximum airflow | m ³ /h | 300 |
| Sound pressure level LpA at 3 m | dB(A) | 33 |
| Heat recovery efficiency, max | % | 79 |
| Heat exchanger type | - | Cross flow |
| Heat exchanger material | - | Polystyrene |
| Weight | kg | 32 |
| Extract filter | - | G4 |
| Supply filter | - | G4, F8 |
| Transported air temperature (max) | °C | 40 |
| Transported air temperature (min) | °C | -25 |
| Ambient air temperature min | °C | 1 |
| Ambient air temperature max | °C | 40 |

| | | |
|----------------------------------------|---|------|
| Ambient air humidity max | % | 80 |
| Ingress protection rating | - | IP22 |
| Ingress protection rating of the drive | - | IP44 |

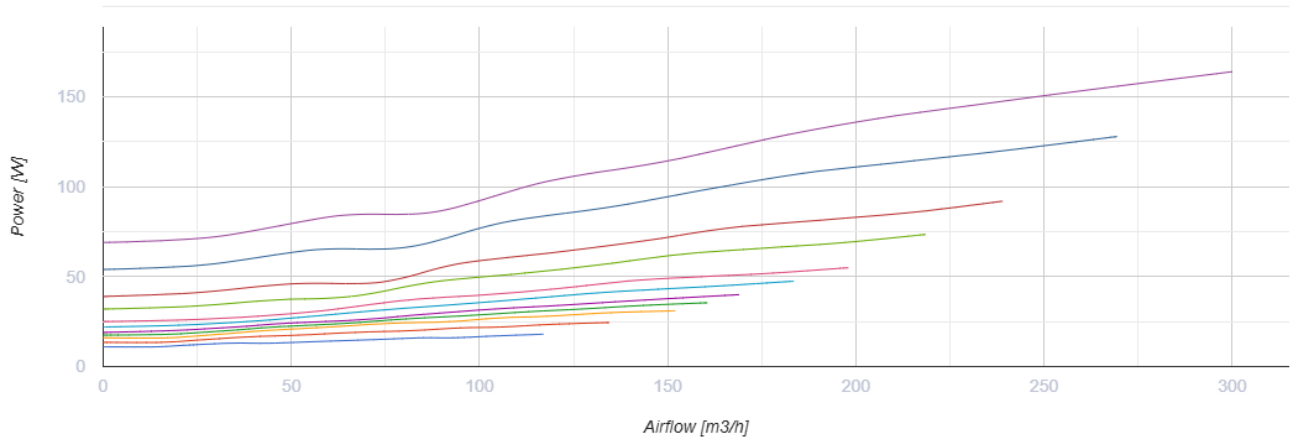
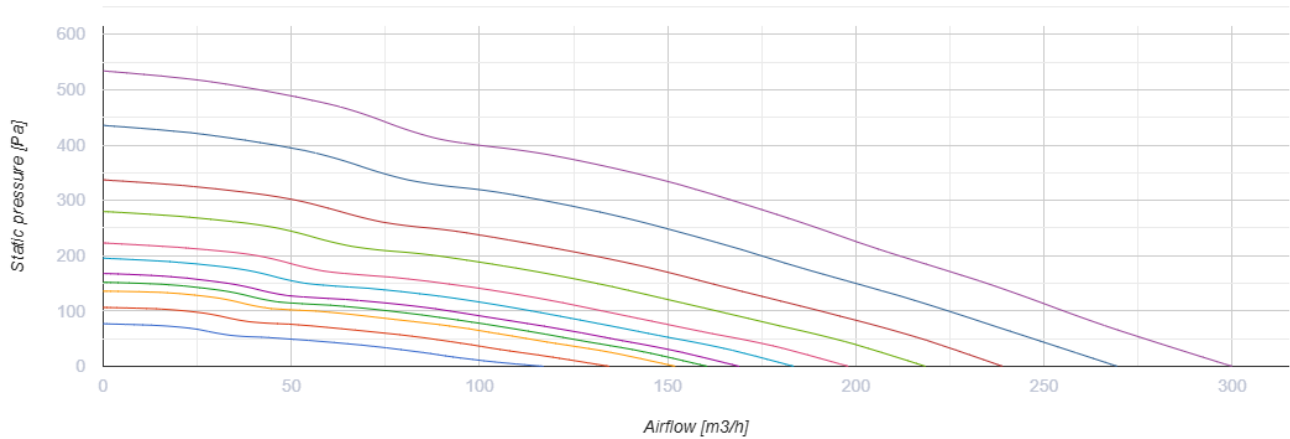

Dimensions

| ØD | B | H | H1 | L | L1 |
|-----|-----|-----|----|-----|-----|
| 125 | 300 | 443 | 63 | 713 | 810 |

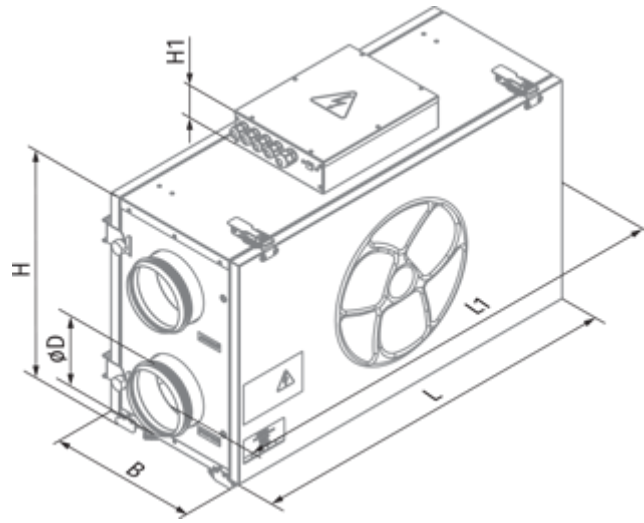

Ecodesign

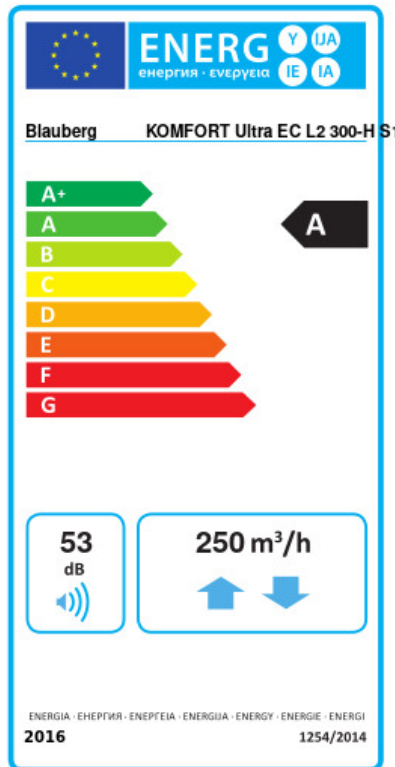

| | | | | | | |
|-------------------------------------------------------------|-------------------------------------|----|---------|---|------|---|
| Trademark | Blauberg | | | | | |
| Model | KOMFORT Ultra EC L2 300-H S14 white | | | | | |
| Specific energy consumption (SEC) (kWh/(m ² /a)) | Cold | | Average | | Warm | |
| | 70.5 | A+ | 36.6 | A | 14.5 | E |
| Type of ventilation unit | Bidirectional | | | | | |
| Type of drive installed | Variable speed | | | | | |
| Type of heat recovery system | Recuperative | | | | | |
| Thermal efficiency of heat recovery (%) | 62 | | | | | |
| Maximum flow rate (m ³ /h) | 250 | | | | | |
| Electric power input (W) | 150 | | | | | |
| Reference flow rate (m ³ /s) | 0.044 | | | | | |
| Reference pressure difference (Pa) | 50 | | | | | |
| Specific power input (SPI) (W/(m ³ /h)) | 0.313 | | | | | |
| Control typology | Local demand control | | | | | |
| Maximum internal leakage rates (%) | 2.7 | | | | | |
| Maximum external leakage rates (%) | 2.7 | | | | | |
| Sound power level (dB(A)) | 53 | | | | | |
| Declared typology | RVU BVU | | | | | |
| The annual electricity consumption (AEC) (kWh/a) | Cold | | Average | | Warm | |
| | 747 | | 210 | | 165 | |
| The annual heating saved (AHS) (kWh/a) | Cold | | Average | | Warm | |
| | 8047 | | 4114 | | 1860 | |



Accessories

Other accessories



| Name | Photo | Description |
|------------------|-------|-----------------|
| FP 240x184x40 G4 | | G4 panel filter |
| FP 240x184x40 F8 | | |

SB C4 200/240

Other accessories

| Name | Photo | Description |
|----------------------|-----------------------------------------------------------------------------------|-----------------|
| FS2 |  | Humidity sensor |
| CD-1 |  | CO2 sensors |
| CD-2 |  | CO2 sensors |

Other accessories

| Name | Photo | Description |
|-----------------------------|-------------------------------------------------------------------------------------|---------------------------|
| SD 125/600 |  | Silencers for round ducts |
| SD 125/900 |  | Silencers for round ducts |
| SD 125/1200 |  | Silencers for round ducts |

Other accessories

| Name | Photo | Description |
|-------------------------|-------------------------------------------------------------------------------------|-----------------------------------------------|
| VRV 125 |  | Backdraft dampers with spring for round ducts |
| VKA 125 |  | Air dampers for round ducts |

Other accessories

| Name | Photo | Description |
|------------------------------|-------------------------------------------------------------------------------------|--------------------|
| Belimo TF230 |  | Electric actuators |