



KOMFORT Ultra D 105

Single room heat recovery air handling units

- Maximum airflow: 100
- Sound pressure level LpA at 3 m: 41
- Heat exchanger type: Cross flow
- Extract filter: G4
- Supply filter: G4
- Sound insulation
- Motor type: AC
- Enthalpy heat exchanger
- Control: Speed switch
- Casing material: Galvanized steel

	Unit of measurement	KOMFORT Ultra D 105		
Connected air duct size	mm	125		
Speed	-	3		
Phases	-	1		
Minimum supply voltage	V	230		
Maximum supply voltage	V	230		
Power supply frequency	Hz	50		
Rated power	W	56		
Unit current	A	0.34		
Maximum airflow	m ³ /h	55	74	100
Sound pressure level LpA at 3 m	dB(A)	24	32	41
Heat recovery efficiency, max	%	72		
Heat exchanger type	-	Cross flow		
Heat exchanger material	-	Enthalpy		
Weight	kg	10		
Extract filter	-	G4		
Supply filter	-	G4		
Transported air temperature (max)	°C	40		
Transported air temperature (min)	°C	-25		
Ambient air temperature min	°C	1		
Ambient air temperature max	°C	40		
Ambient air humidity max	%	60		

Ingress protection rating	-	IP22
Ingress protection rating of the drive	-	IP44

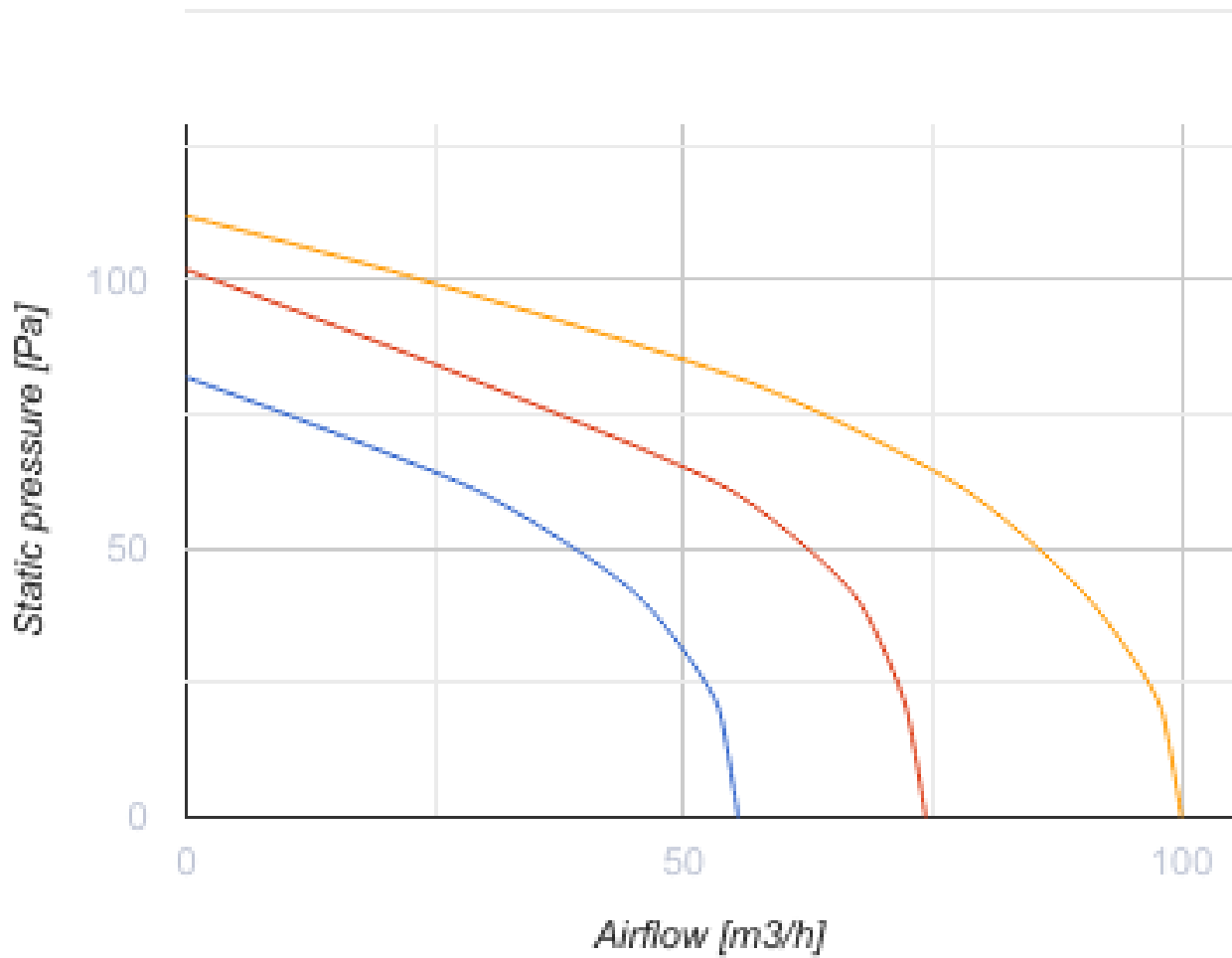

Dimensions

ØD	B	B1	H	L	L1	L2
125	374	404	224	497	397	595

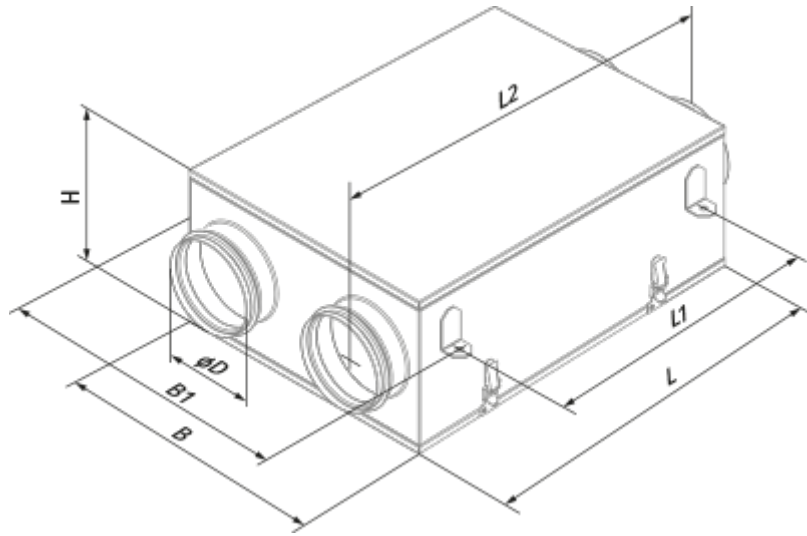

Ecodesign

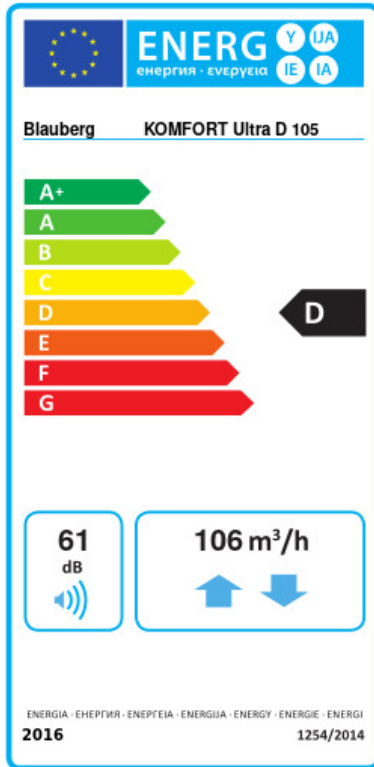



Trademark	Blauberg					
Model	KOMFORT Ultra D 105					
Specific energy consumption (SEC) (kWh/(m ² /a))	Cold		Average		Warm	
	-55.3	A+	-23	D	-1.8	F
Type of ventilation unit	Bidirectional					
Type of drive installed	Multi-speed					
Type of heat recovery system	Recuperative					
Thermal efficiency of heat recovery (%)	70					
Maximum flow rate (m ³ /h)	106					
Electric power input (W)	56					
Reference flow rate (m ³ /s)	0.021					
Reference pressure difference (Pa)	50					
Specific power input (SPI) (W/(m ³ /h))	0.512					
Control typology	Manual control					
Maximum internal leakage rates (%)	2.7					
Maximum external leakage rates (%)	2.7					
Declared typology	RVU BVU					
Sound power level (dB(A))	61					
The annual electricity consumption (AEC) (kWh/a)	Cold		Average		Warm	
	1224		687		642	
The annual heating saved (AHS) (kWh/a)	Cold		Average		Warm	
	7717		3945		1784	

Accessories

Other accessories

Name	Photo	Description
FP 240x202x8 G4		G4 panel filter
SB C4 200/190		

Other accessories

Name	Photo	Description
SD 125/600		Silencers for round ducts
SD 125/900		Silencers for round ducts
SD 125/1200		Silencers for round ducts

Other accessories

Name	Photo	Description
VRV 125		Backdraft dampers with spring for round ducts