



KOMFORT Roto EC S6K 200 S21

Air handling units with rotary heat exchanger

- Maximum airflow: 270
- Sound pressure level LpA at 3 m: 28
- Heat exchanger type: Rotary
- Extract filter: G4
- Supply filter: G4 + F7
- Sound insulation
- Motor type: EC
- BMS protocol: ModBus
- Control: Smartphone
- Casing material: Galvanized steel
- Humidity sensor: Optional
- CO2 sensor: Optional
- VOC sensor: Optional
- PM2.5 sensor: Optional

| | Unit of measurement | KOMFORT Roto EC S6K 200 S21 |
|-----------------------------------|---------------------|-----------------------------|
| Connected air duct size | mm | 125 |
| Speed | - | 1 |
| Phases | - | 1 |
| Minimum supply voltage | V | 230 |
| Maximum supply voltage | V | 230 |
| Power supply frequency | Hz | 50/60 |
| Rated power | W | 118 |
| Power of electrical reheater | W | 0 |
| Unit current | A | 1 |
| Maximum airflow | m ³ /h | 270 |
| Sound pressure level LpA at 3 m | dB(A) | 28 |
| Heat recovery efficiency, max | % | 92 |
| Heat exchanger type | - | Rotary |
| Heat exchanger material | - | Aluminum |
| Weight | kg | 48 |
| Extract filter | - | G4 |
| Supply filter | - | G4 + F7 |
| Transported air temperature (max) | °C | 40 |
| Transported air temperature (min) | °C | -25 |
| Ambient air temperature min | °C | 1 |
| Ambient air temperature max | °C | 40 |

| | | |
|--|---|------|
| Ambient air humidity max | % | 60 |
| Ingress protection rating | - | IP22 |
| Ingress protection rating of the drive | - | IP44 |

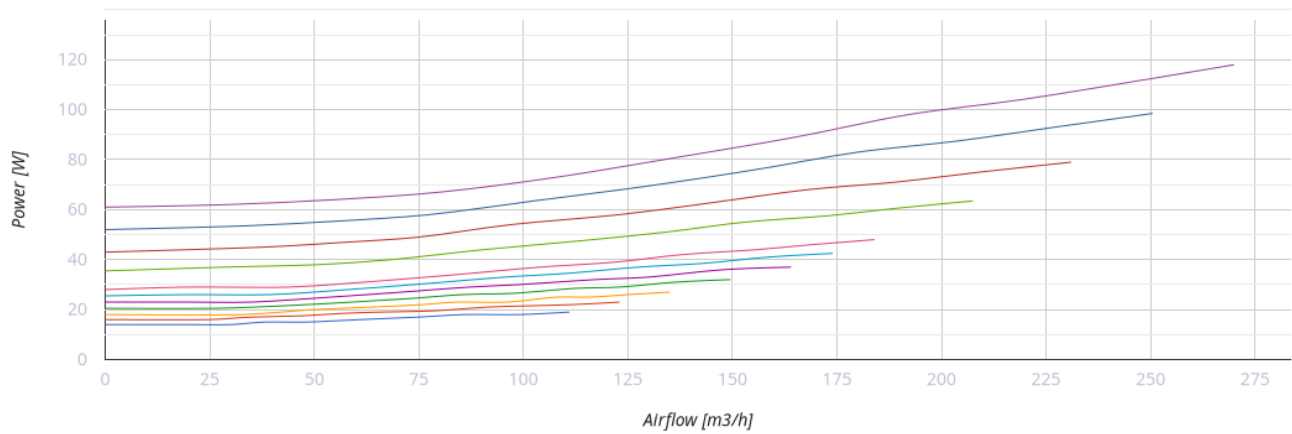
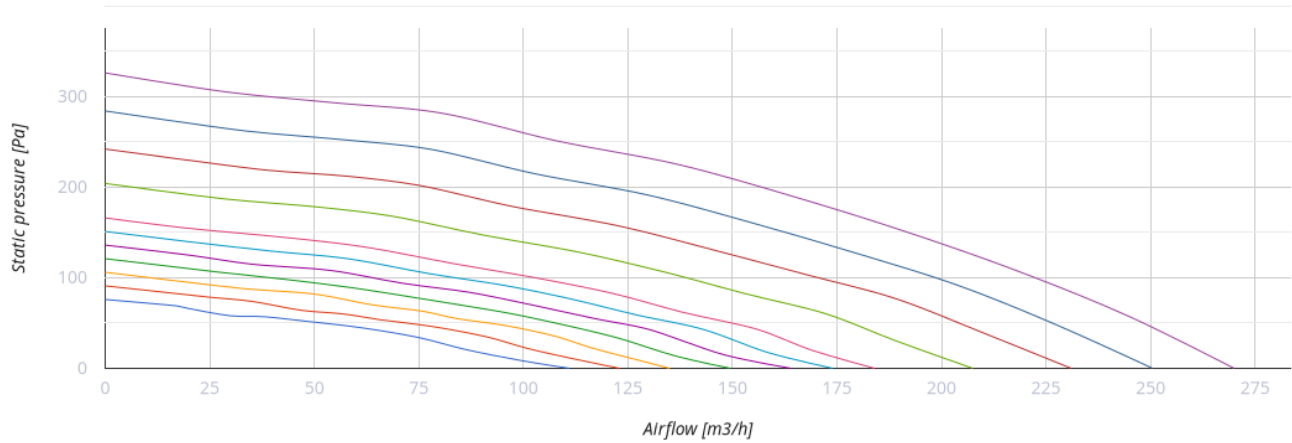

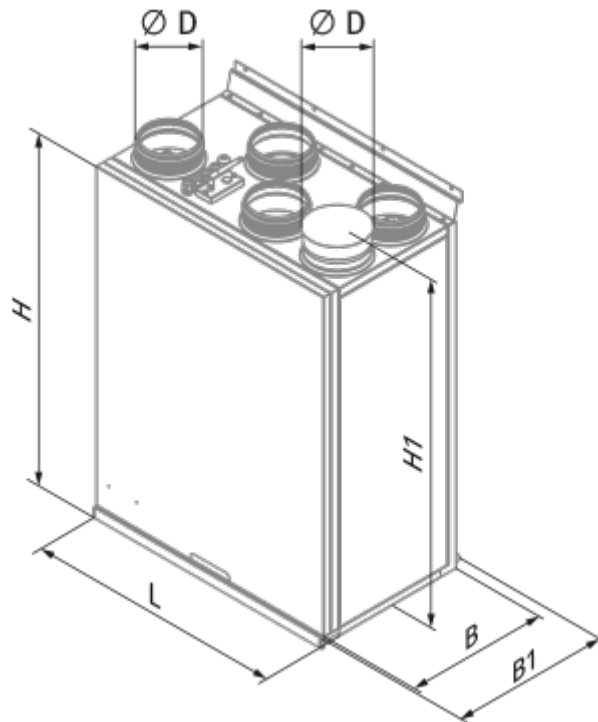

Dimensions

| Ø D | B | B1 | H | H1 | L |
|-----|-----|-----|-----|-----|-----|
| 125 | 348 | 371 | 791 | 865 | 598 |





Accessories

Other accessories



| Name | Photo | Description |
|------------------|---|-----------------|
| FP 284x103x60 G4 |  | G4 panel filter |
| FP 284x103x60 F7 |  | F7 panel filter |

Other accessories



| Name | Photo | Description |
|---------------------------|---|----------------|
| S22 |  | Control panels |
| S22 Wi-Fi |  | Control panels |

| | | |
|---------------------|---|-------------------|
| S25 |  | LCD control panel |
|---------------------|---|-------------------|



Other accessories

| Name | Photo | Description |
|----------------------|---|-----------------|
| FS2 |  | Humidity sensor |
| CD-1 |  | CO2 sensors |
| CD-2 |  | CO2 sensors |

Other accessories

| Name | Photo | Description |
|-----------------------------|---|---------------------------|
| SD 125/600 |  | Silencers for round ducts |
| SD 125/900 |  | Silencers for round ducts |
| SD 125/1200 |  | Silencers for round ducts |

Other accessories

| Name | Photo | Description |
|-------------------------|---|---|
| VRV 125 |  | Backdraft dampers with spring for round ducts |
| VKA 125 |  | Air dampers for round ducts |