



# KOMFORT Roto EC S6EK 200 S21

Air handling units with rotary heat exchanger

- Power of electrical reheater: 700
- Maximum airflow: 270
- Sound pressure level LpA at 3 m: 28
- Heat exchanger type: Rotary
- Extract filter: G4
- Supply filter: G4 + F7
- Sound insulation
- Motor type: EC
- Reheater: Electric
- BMS protocol: ModBus
- Control: Smartphone
- Casing material: Galvanized steel
- Humidity sensor: Optional
- CO2 sensor: Optional
- VOC sensor: Optional
- PM2.5 sensor: Optional

	Unit of measurement	KOMFORT Roto EC S6EK 200 S21
Connected air duct size	mm	125
Speed	-	1
Phases	-	1
Minimum supply voltage	V	230
Maximum supply voltage	V	230
Power supply frequency	Hz	50/60
Rated power	W	118
Power of electrical reheater	W	700
Unit current	A	4
Maximum airflow	m <sup>3</sup> /h	270
Sound pressure level LpA at 3 m	dB(A)	28
Heat recovery efficiency, max	%	92
Heat exchanger type	-	Rotary
Heat exchanger material	-	Aluminum
Weight	kg	48
Extract filter	-	G4
Supply filter	-	G4 + F7
Transported air temperature (max)	°C	40
Transported air temperature (min)	°C	-25
Ambient air temperature min	°C	1

Ambient air temperature max	°C	40
Ambient air humidity max	%	60
Ingress protection rating	-	IP22
Ingress protection rating of the drive	-	IP44

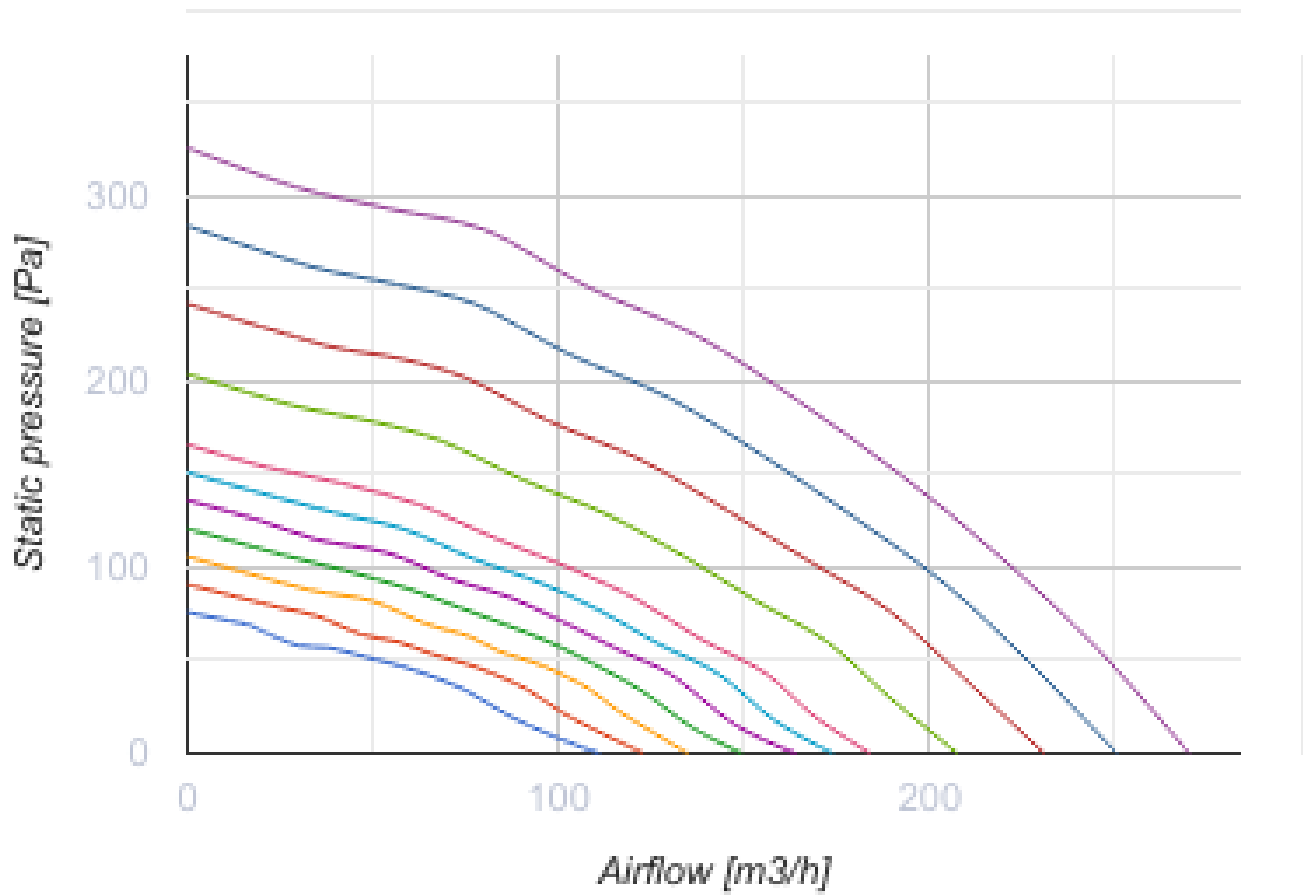

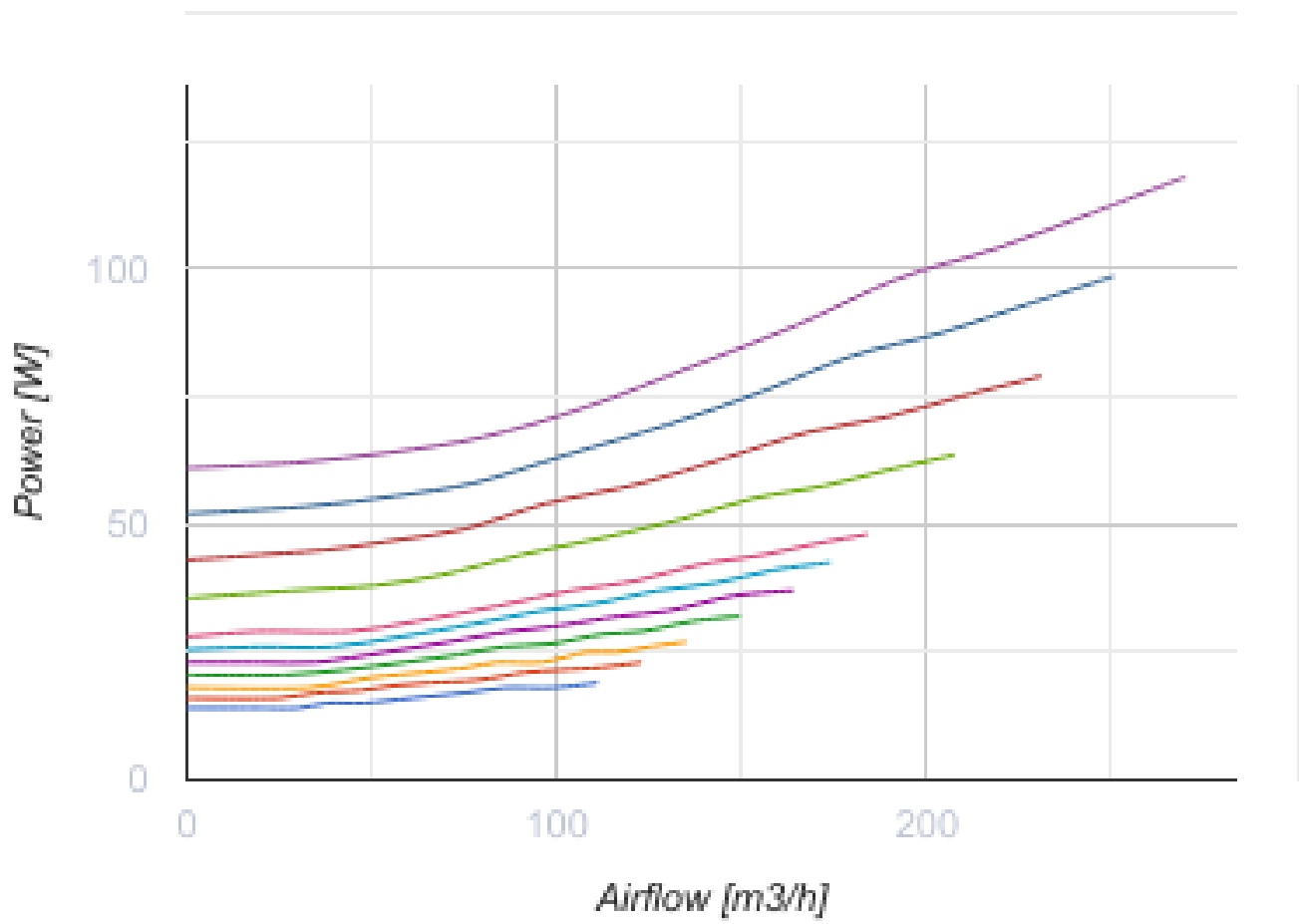

## Dimensions

Ø D	B	B1	H	H1	L
125	348	371	791	865	598

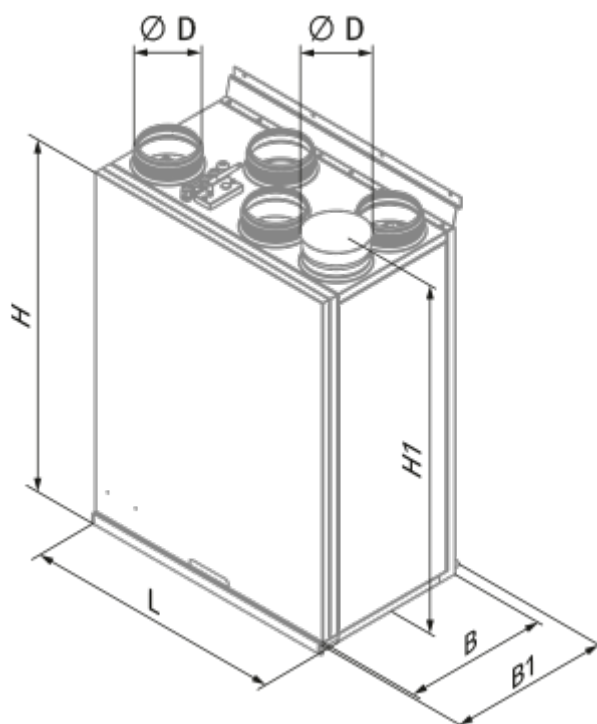



## Accessories

### Other accessories



Name	Photo	Description
FP 284x103x60 G4		G4 panel filter
FP 284x103x60 F7		F7 panel filter

### Other accessories



Name	Photo	Description
<a href="#">S22</a>		Control panels
<a href="#">S22 Wi-Fi</a>		Control panels

<a href="#">S25</a>		LCD control panel
---------------------	---	-------------------



### Other accessories

Name	Photo	Description
<a href="#">FS2</a>		Humidity sensor
<a href="#">CD-1</a>		CO2 sensors
<a href="#">CD-2</a>		CO2 sensors

### Other accessories

Name	Photo	Description
<a href="#">SD 125/600</a>		Silencers for round ducts
<a href="#">SD 125/900</a>		Silencers for round ducts
<a href="#">SD 125/1200</a>		Silencers for round ducts

### Other accessories

Name	Photo	Description
<a href="#">VRV 125</a>		Backdraft dampers with spring for round ducts
<a href="#">VKA 125</a>		Air dampers for round ducts