



KOMFORT Roto EC LW 1200-2 S18

Air handling units with rotary heat exchanger

- Maximum airflow: 1200
- Sound pressure level LpA at 3 m: 60
- Heat exchanger type: Rotary
- Extract filter: G4
- Supply filter: G4
- Sound insulation
- Motor type: EC
- Reheater: Water
- Control: Wired control panel
- Casing material: Aluzinc steel
- Humidity sensor: Optional
- CO2 sensor: Optional
- VOC sensor: Optional
- PM2.5 sensor: Optional

	Unit of measurement	KOMFORT Roto EC LW 1200-2 S18
Connected air duct size	mm	315
Speed	-	1
Phases	-	1
Minimum supply voltage	V	230
Maximum supply voltage	V	230
Power supply frequency	Hz	50/60
Rated power	W	570
Unit current	A	2.5
Maximum airflow	m ³ /h	1200
Sound pressure level LpA at 3 m	dB(A)	60
Heat recovery efficiency, max	%	95
Heat exchanger type	-	Rotary
Heat exchanger material	-	Aluminum
Weight	kg	165
Extract filter	-	G4
Supply filter	-	G4
Transported air temperature (max)	°C	40
Transported air temperature (min)	°C	-25
Ambient air temperature min	°C	1
Ambient air temperature max	°C	40

Ambient air humidity max	%	80
Ingress protection rating	-	IP22
Ingress protection rating of the drive	-	IP44

Dimensions

ØD	B	B1	H	L
314	745	460	880	1335

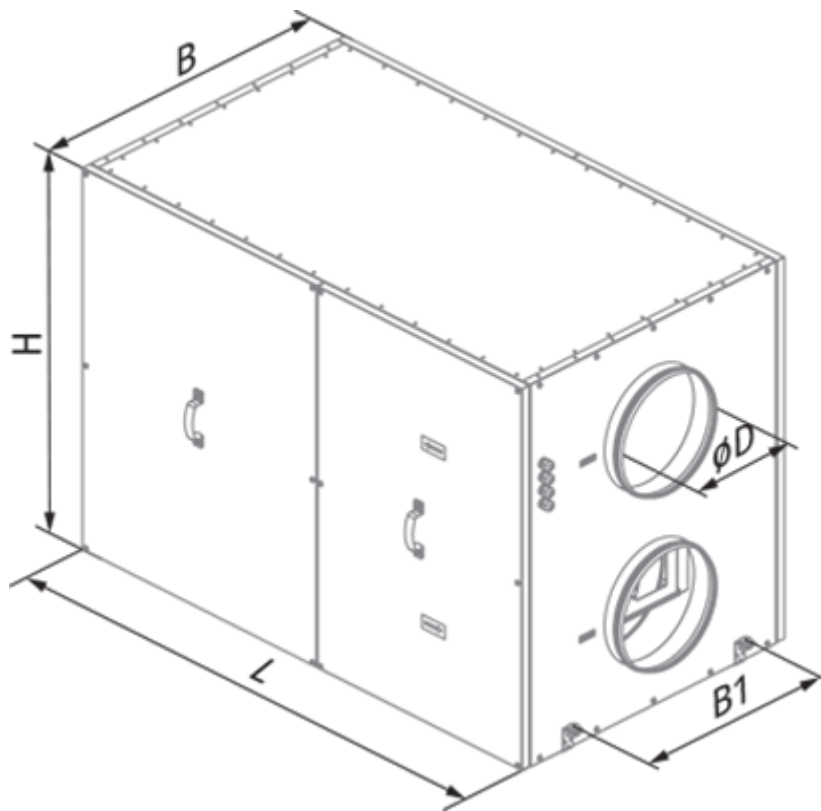

Accessories



Other accessories

Name	Photo	Description
FP 700x410x48 G4		G4 panel filter
FPT 700x423x27 G4		



Other accessories

Name	Photo	Description
WMG 3/4-4		Water mixing units

Other accessories

Name	Photo	Description
SD 315/600		Silencers for round ducts
SD 315/900		Silencers for round ducts
SD 315/1200		Silencers for round ducts

Other accessories

Name	Photo	Description
VRV 315		Backdraft dampers with spring for round ducts
VRVS 315		Backdraft air dampers for round ducts

Other accessories

Name	Photo	Description
FS2		Humidity sensor