

KOMFORT Roto EC D2E 350 R S21

Suspended heat recovery air handling units



- Power of electrical reheater: 1400
- Maximum airflow: 400
- Sound pressure level LpA at 3 m: 33
- Heat exchanger type: Rotary
- Extract filter: G4
- Supply filter: G4, F7 (option: H13)
- Sound insulation
- Motor type: EC
- Reheater: Electric
- BMS protocol: ModBus
- Control: Smartphone
- Casing material: Galvanized steel
- Humidity sensor: Optional
- CO2 sensor: Optional
- VOC sensor: Optional
- PM2.5 sensor: Optional

	Unit of measurement	KOMFORT Roto EC D2E 350 R S21
Connected air duct size	mm	160
Speed	-	1
Phases	-	1
Minimum supply voltage	V	230
Maximum supply voltage	V	230
Power supply frequency	Hz	50/60
Rated power	W	200
Power of electrical reheater	W	1400
Unit current	A	6.9
Maximum airflow	m ³ /h	400
Sound pressure level LpA at 3 m	dB(A)	33
Heat recovery efficiency, max	%	87
Heat exchanger type	-	Rotary
Heat exchanger material	-	Aluminum
Weight	kg	79
Extract filter	-	G4
Supply filter	-	G4, F7 (option: H13)
Transported air temperature (max)	°C	40
Transported air temperature (min)	°C	-25
Ambient air temperature min	°C	1

Ambient air temperature max	°C	40
Ambient air humidity max	%	80
Ingress protection rating	-	IP22
Ingress protection rating of the drive	-	IP44

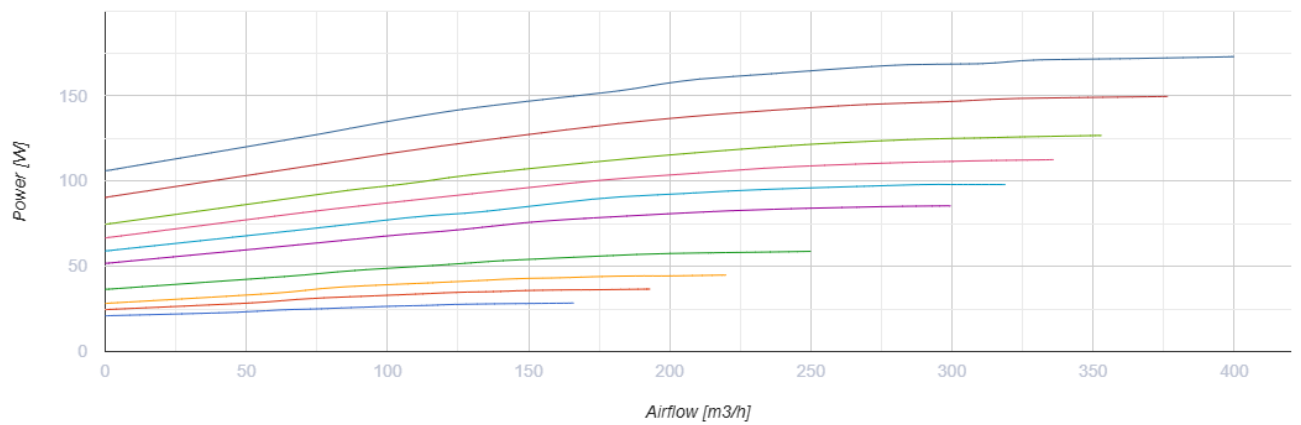
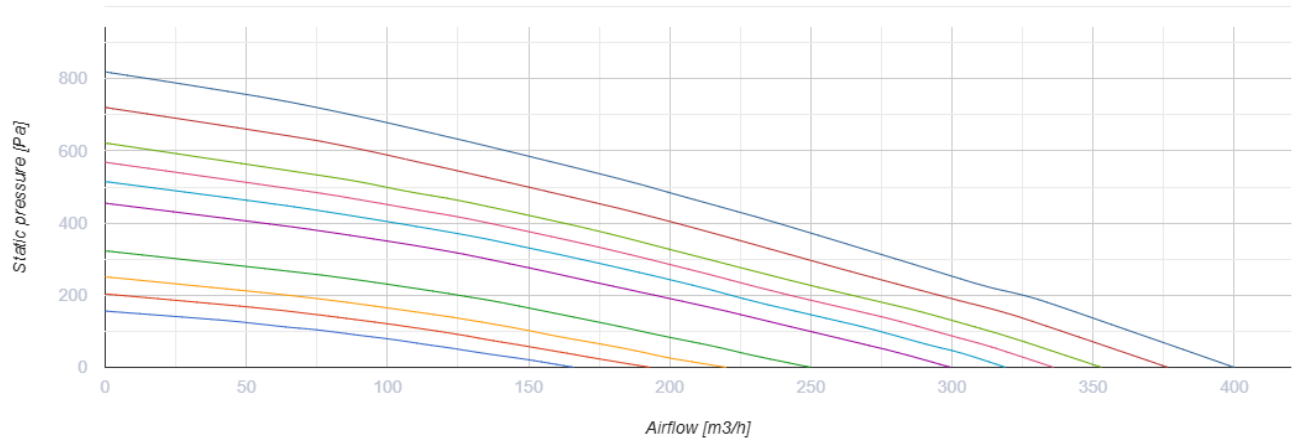

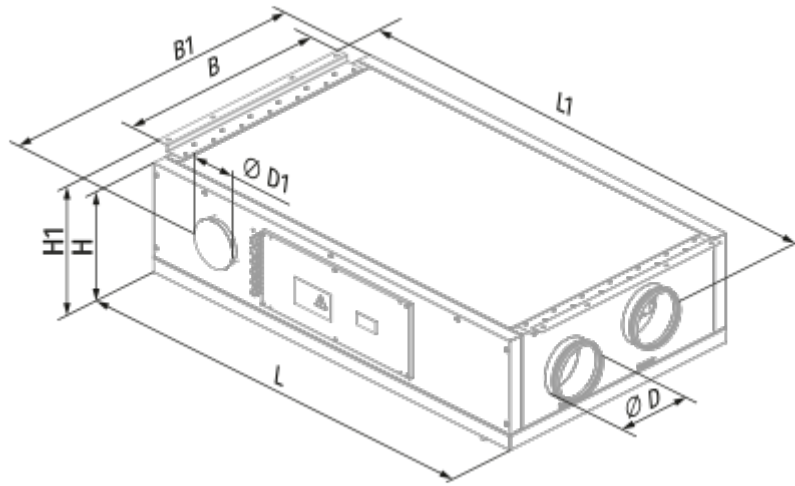

Dimensions

Ø D	Ø D1	B	B1	H	H1	L	L1
160	125	798	847	225	245	1362	1457



FP 372x180x48 F7		F7 panel filter
FP 372x180x48 H13		

Other accessories

Name	Photo	Description
S22		Control panels
S22 Wi-Fi		Control panels
S25		LCD control panel

Other accessories

Name	Photo	Description
FS2		Humidity sensor

Other accessories

Name	Photo	Description
DAH 251-13		Kitchen exhaust hood

Other accessories

Name	Photo	Description
VRV 160		Backdraft dampers with spring for round ducts
VKA 160		Air dampers for round ducts