

KOMFORT EC DBE 550 R S21 DTV

Suspended heat recovery air handling units



- Power of electrical reheater: 2000
- Maximum airflow: 608
- Sound pressure level LpA at 3 m: 30
- Heat exchanger type: Counter flow
- Extract filter: G4
- Supply filter: G4 (F7 option)
- Sound insulation
- Motor type: EC
- Bypass: Auto
- Reheater: Electric
- Preheater: Optional
- BMS protocol: ModBus
- Control: Smartphone
- Casing material: Galvanized steel
- Humidity sensor: Optional
- CO2 sensor: Optional
- VOC sensor: Optional
- PM2.5 sensor: Optional

	Unit of measurement	KOMFORT EC DBE 550 R S21 DTV
Connected air duct size	mm	200
Speed	-	1
Phases	-	1
Minimum supply voltage	V	230
Maximum supply voltage	V	230
Power supply frequency	Hz	50/60
Rated power	W	322
Power of electrical reheater	W	2000
Unit current	A	11.1
Maximum airflow	m ³ /h	608
Sound pressure level LpA at 3 m	dB(A)	30
Heat recovery efficiency, max	%	90
Heat exchanger type	-	Counter flow
Heat exchanger material	-	Polystyrene
Weight	kg	67
Extract filter	-	G4
Supply filter	-	G4 (F7 option)
Transported air temperature (max)	°C	40
Transported air temperature (min)	°C	-25

Ambient air temperature min	°C	1
Ambient air temperature max	°C	40
Ambient air humidity max	%	60
Ingress protection rating	-	IP22
Ingress protection rating of the drive	-	IP44

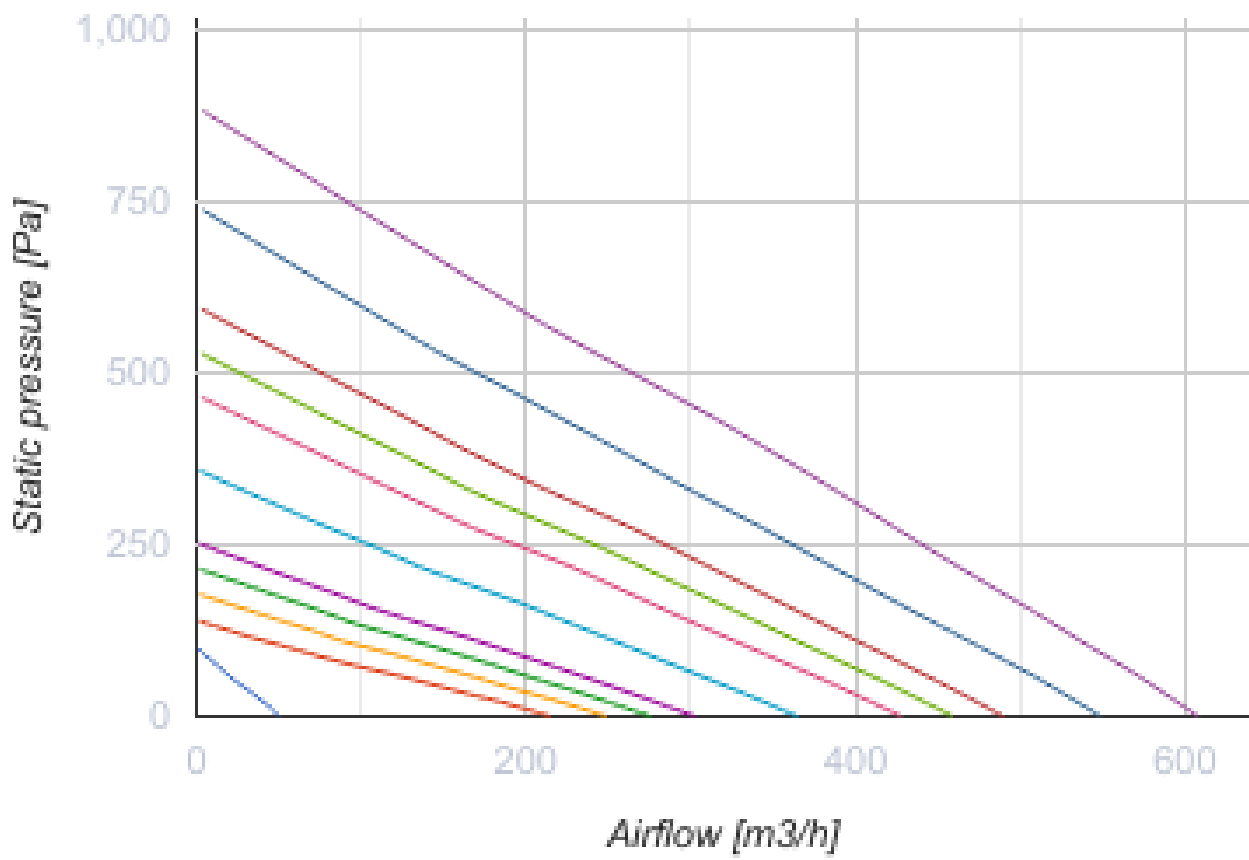

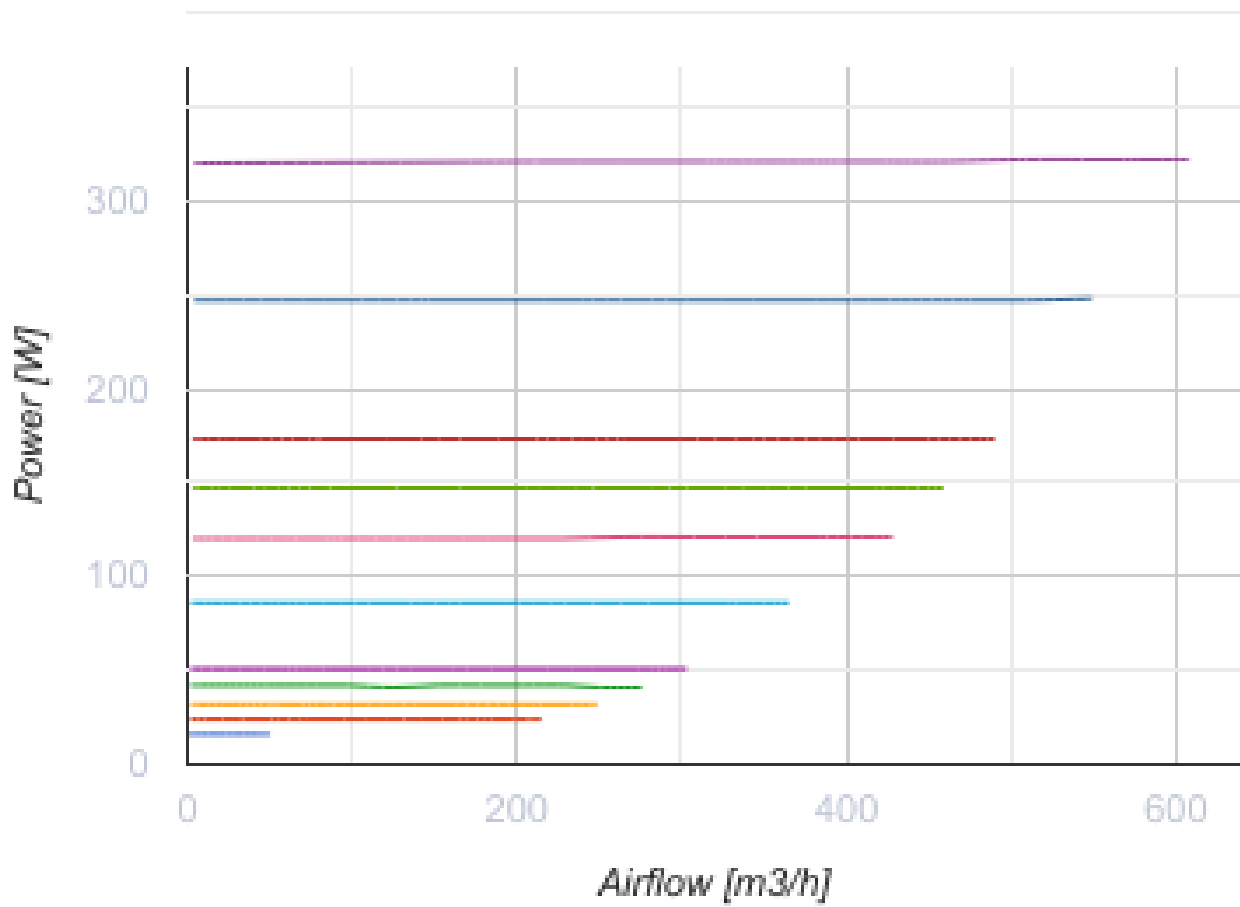

Dimensions

Ø D	B	B1	H	L	L1
200	827	960	280	1238	1291

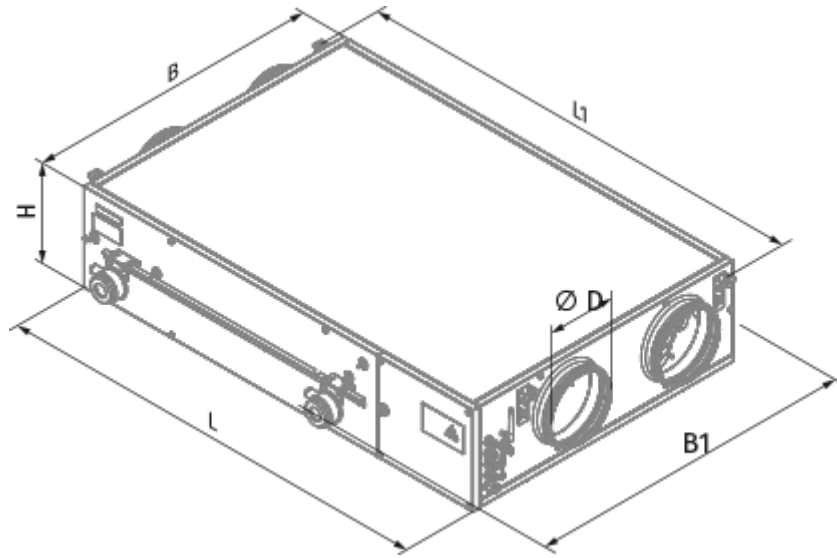

Ecodesign

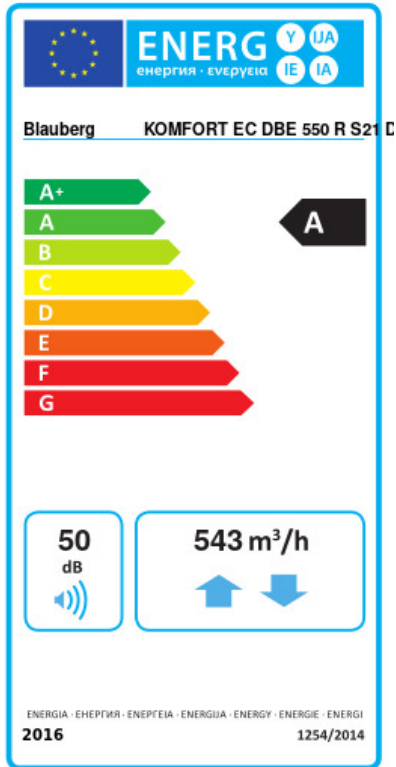

Trademark	Blauberg					
Model	KOMFORT EC DBE 550 R S21 DTV					
Specific energy consumption (SEC) (kWh/(m ² /a))	Cold	Average		Warm		
	78.2	A+	40.4	A	16.2	E
Type of ventilation unit	Bidirectional					
Type of drive installed	Variable speed					
Type of heat recovery system	Recuperative					
Thermal efficiency of heat recovery (%)	81					
Maximum flow rate (m ³ /h)	543					
Electric power input (W)	322					
Reference flow rate (m ³ /s)	0.106					
Reference pressure difference (Pa)	50					
Specific power input (SPI) (W/(m ³ /h))	0.316					
Control typology	Local demand control					
Maximum internal leakage rates (%)	2.7					
Maximum external leakage rates (%)	2.7					
Sound power level (dB(A))	50					
Declared typology	RVU BVU					
The annual electricity consumption (AEC) (kWh/a)	Cold	Average		Warm		
	749	212		167		
The annual heating saved (AHS) (kWh/a)	Cold	Average		Warm		
	8817	4507		2038		



Accessories

Other accessories



Name	Photo	Description
FP 782x128x20 G4		G4 panel filter
FPT 392x236x27 G4		

FPT 392x236x27 F7



Other accessories

Name	Photo	Description
S22		Control panels
S22 Wi-Fi		Control panels
S25		LCD control panel

Other accessories

Name	Photo	Description
FS2		Humidity sensor
CD-1		CO2 sensors
CD-2		CO2 sensors

Other accessories



Name	Photo	Description
EVH 200-1.2-1 S21 V.2		Electric duct preheater for heat exchanger freeze protection
EVH 200-1.7-1 S21 V.2		Electric duct preheater for heat exchanger freeze protection
EVH 200-2.0-1 S21 V.2		Electric duct preheater for heat exchanger freeze protection

Other accessories

Name	Photo	Description
------	-------	-------------

SFK 20x32		Hydraulic syphon for condensate drainage
---------------------------	---	--

Other accessories

Name	Photo	Description
SD 200/600		Silencers for round ducts
SD 200/900		Silencers for round ducts
SD 200/1200		Silencers for round ducts

Other accessories

Name	Photo	Description
VRV 200		Backdraft dampers with spring for round ducts
VKA 200		Air dampers for round ducts

Other accessories

Name	Photo	Description
Belimo TF230		Electric actuators