

Iso-Mix 315 W1

Mixed-flow inline fans in sound-insulated casings



- Maximum airflow: 1920
- Sound pressure level LpA at 3 m: 40
- Sound insulation
- Motor type: AC
- Impeller type: Mixed-flow
- Casing material: Coated steel
- Installation in any position
- Cable with mains plug

	Unit of measurement	Iso-Mix 315 W1	
Connected air duct size	mm	315	
Speed	-	2	
Phases	-	1	
Minimum supply voltage	V	230	
Maximum supply voltage	V	230	
Power supply frequency	Hz	50/60	
Rated power	W	230	330
Unit current	A	0.93	1.41
Maximum airflow	m ³ /h	1510	1920
Sound pressure level LpA at 3 m	dB(A)	36	40
Weight	kg	25	
Transported air temperature (max)	°C	60	
Ingress protection rating	-	IPX4	
Ingress protection rating of the drive	-	IP44	

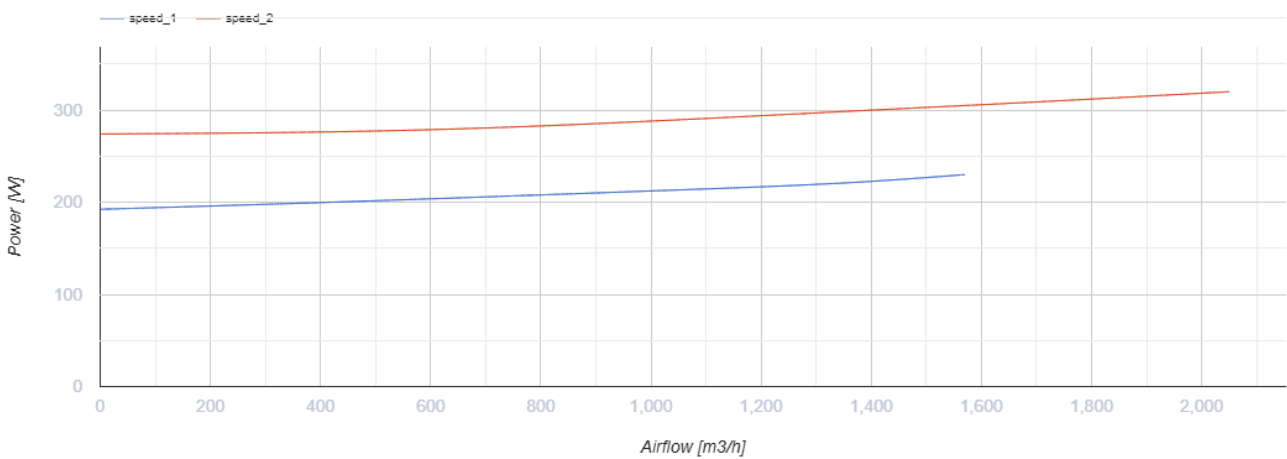
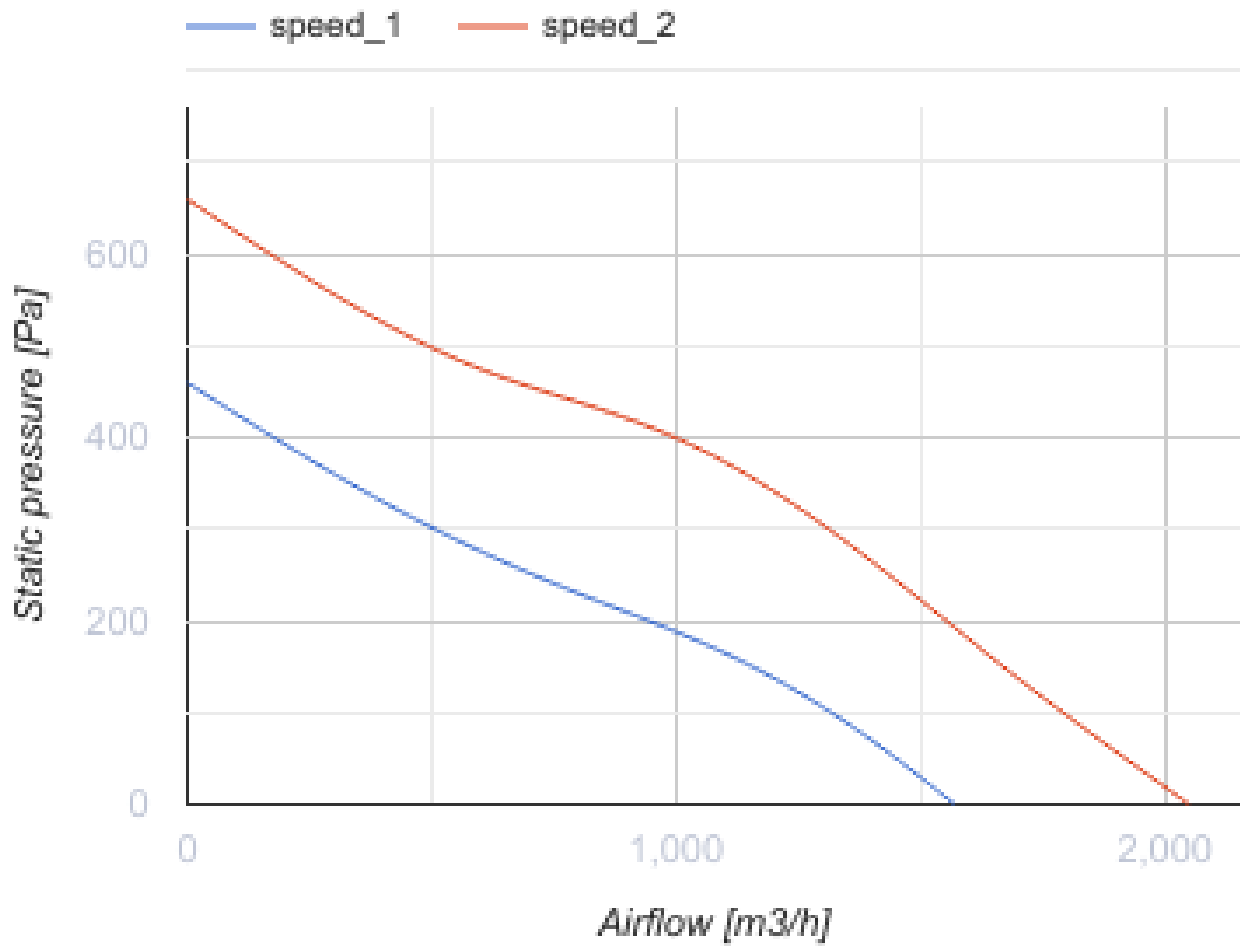

Dimensions

$\varnothing D$	B	B1	L	H
313	432	520	780	434

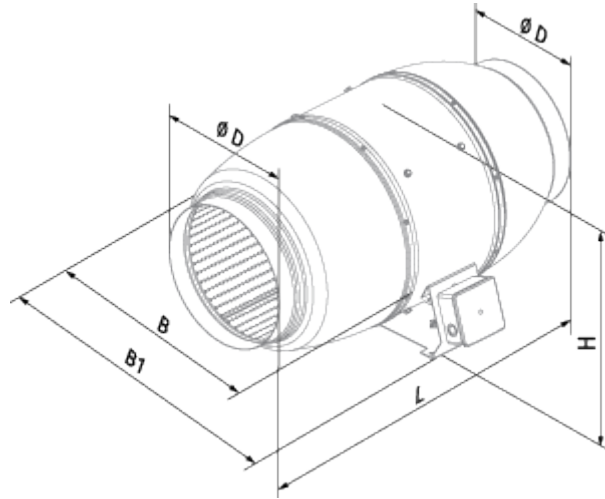





Ecodesign

Trademark	Blauberg
Model	Iso-Mix 315 W1
Type of ventilation unit	Unidirectional
Type of drive installed	External MSD or VSD
Type of heat recovery system	None
Nominal flow rate (m ³ /s)	0.309
Nominal external pressure (Pa)	327
Maximum external leakage rates (%)	2.7
Static efficiency (%)	32.5
Declared typology	NRVU UVU
Effective electric power input (kW)	0.317
Sound power level (dB(A))	58



Accessories

Other accessories



Name	Photo	Description
CDP-2/5		Multi-speed switch
CDT E1.8		Thyristor speed controller
CDP-2/10		Multi-speed switch
CDT1 E1.5		Multi-speed switches

Other accessories



Name	Photo	Description
TE / TI 1.5		Timers

HSE / HSI 1.5		Sensors
LSE / LSI 1.5		Sensors
IRSE / IRSI 1.5		Sensors

Other accessories





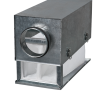
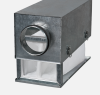

Name	Photo	Description
SD 315/1200		Silencers for round ducts
SD 315/900		Silencers for round ducts
SD 315/600		Silencers for round ducts

Other accessories

Name	Photo	Description
KFBK 315		Filter boxes for round ducts
KFBT 315 G4		Filter boxes with pocket filters for round ducts
KFBT 315 F5		Filter boxes with pocket filters for round ducts
KFBT 315 F7		Filter boxes with pocket filters for round ducts

Other accessories

Name	Photo	Description
EKH 315-1.2		Duct electrical heaters for round ducts

EKH 315-2.0		Duct electrical heaters for round ducts
EKH 315-2.4		Duct electrical heaters for round ducts
EKH 315-3.6		Duct electrical heaters for round ducts
EKH 315-6.0		Duct electrical heaters for round ducts
EKH 315-9.0		Duct electrical heaters for round ducts
WKH 315-2		Duct water heaters for round ducts
WKH 315-4		Duct water heaters for round ducts

Other accessories

Name	Photo	Description
VRV 315		Backdraft dampers with spring for round ducts
VKA 315		Air dampers for round ducts