



# Iso-Mix 315 USW1

Mixed-flow inline fans in sound-insulated casings

- Maximum airflow: 1920
- Sound pressure level LpA at 3 m: 40
- Sound insulation
- Motor type: AC
- Control: Built-in speed controller
- Impeller type: Mixed-flow
- Casing material: Coated steel
- Installation in any position
- Cable with mains plug

	Unit of measurement	Iso-Mix 315 USW1	
Connected air duct size	mm	315	
Speed	-	2	
Phases	-	1	
Minimum supply voltage	V	230	
Maximum supply voltage	V	230	
Power supply frequency	Hz	50/60	
Rated power	W	230	330
Unit current	A	0.93	1.41
Maximum airflow	m <sup>3</sup> /h	1510	1920
Sound pressure level LpA at 3 m	dB(A)	36	40
Weight	kg	25	
Transported air temperature (max)	°C	60	
Ingress protection rating	-	IPX4	
Ingress protection rating of the drive	-	IP44	

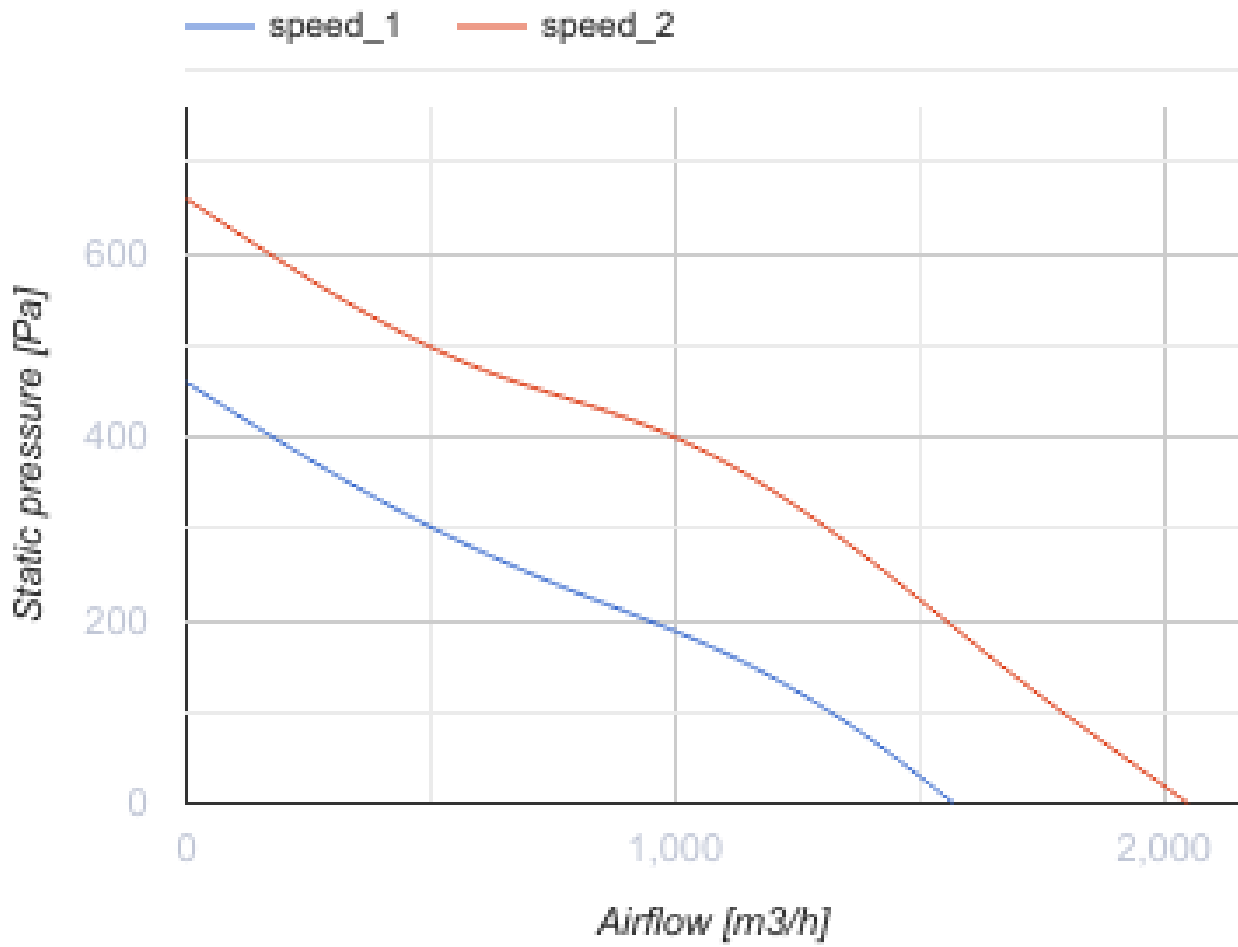

### Dimensions

ØD	B	B1	L	H
313	432	520	780	434

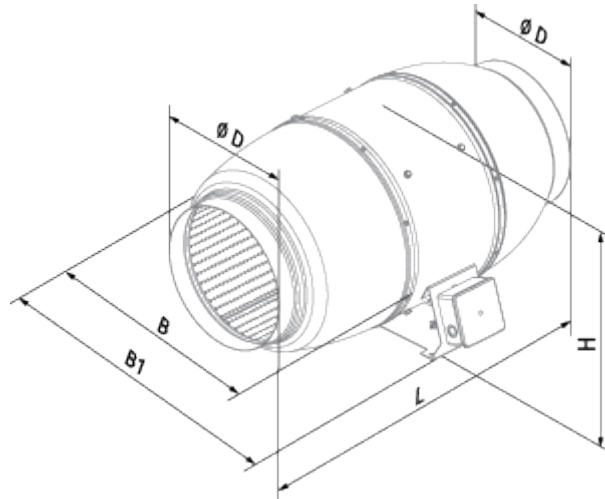





## Ecodesign

Trademark	Blauberg
Model	Iso-Mix 315 USW1
Type of ventilation unit	Unidirectional
Type of drive installed	External MSD or VSD
Type of heat recovery system	None
Nominal flow rate (m <sup>3</sup> /s)	0.309
Nominal external pressure (Pa)	327
Maximum external leakage rates (%)	2.7
Static efficiency (%)	32.5
Declared typology	NRVU UVU
Effective electric power input (kW)	0.317
Sound power level (dB(A))	58



## Accessories

### Other accessories



Name	Photo	Description
<a href="#">CDP-2/5</a>		Multi-speed switch
<a href="#">CDT E1.8</a>		Thyristor speed controller
<a href="#">CDP-2/10</a>		Multi-speed switch
<a href="#">CDT1 E1.5</a>		Multi-speed switches

### Other accessories





Name	Photo	Description
<a href="#">TE / TI 1.5</a>		Timers

<a href="#">HSE / HSI 1.5</a>		Sensors
<a href="#">LSE / LSI 1.5</a>		Sensors
<a href="#">IRSE / IRSI 1.5</a>		Sensors

### Other accessories







Name	Photo	Description
<a href="#">SD 315/1200</a>		Silencers for round ducts
<a href="#">SD 315/900</a>		Silencers for round ducts
<a href="#">SD 315/600</a>		Silencers for round ducts

### Other accessories



Name	Photo	Description
<a href="#">KFBK 315</a>		Filter boxes for round ducts
<a href="#">KFBT 315 G4</a>		Filter boxes with pocket filters for round ducts
<a href="#">KFBT 315 F5</a>		Filter boxes with pocket filters for round ducts
<a href="#">KFBT 315 F7</a>		Filter boxes with pocket filters for round ducts

### Other accessories

Name	Photo	Description
<a href="#">EKH 315-1.2</a>		Duct electrical heaters for round ducts

<a href="#">EKH 315-2.0</a>		Duct electrical heaters for round ducts
<a href="#">EKH 315-2.4</a>		Duct electrical heaters for round ducts
<a href="#">EKH 315-3.6</a>		Duct electrical heaters for round ducts
<a href="#">EKH 315-6.0</a>		Duct electrical heaters for round ducts
<a href="#">EKH 315-9.0</a>		Duct electrical heaters for round ducts
<a href="#">WKH 315-2</a>		Duct water heaters for round ducts
<a href="#">WKH 315-4</a>		Duct water heaters for round ducts

### Other accessories

Name	Photo	Description
<a href="#">VRV 315</a>		Backdraft dampers with spring for round ducts
<a href="#">VKA 315</a>		Air dampers for round ducts