

# Iso-Mix 250 US

Mixed-flow inline fans in sound-insulated casings



- Maximum airflow: 1315
- Sound pressure level LpA at 3 m: 38
- Sound insulation
- Motor type: AC
- Control: Built-in speed controller
- Impeller type: Mixed-flow
- Casing material: Coated steel
- Installation in any position

	Unit of measurement	Iso-Mix 250 US	
Connected air duct size	mm	250	
Speed	-	2	
Phases	-	1	
Minimum supply voltage	V	230	
Maximum supply voltage	V	230	
Power supply frequency	Hz	50/60	
Rated power	W	127	178
Unit current	A	0.79	0.52
Maximum airflow	m <sup>3</sup> /h	1035	1315
Sound pressure level LpA at 3 m	dB(A)	34	38
Weight	kg	15	
Transported air temperature (max)	°C	60	
Ingress protection rating	-	IPX4	
Ingress protection rating of the drive	-	IP44	

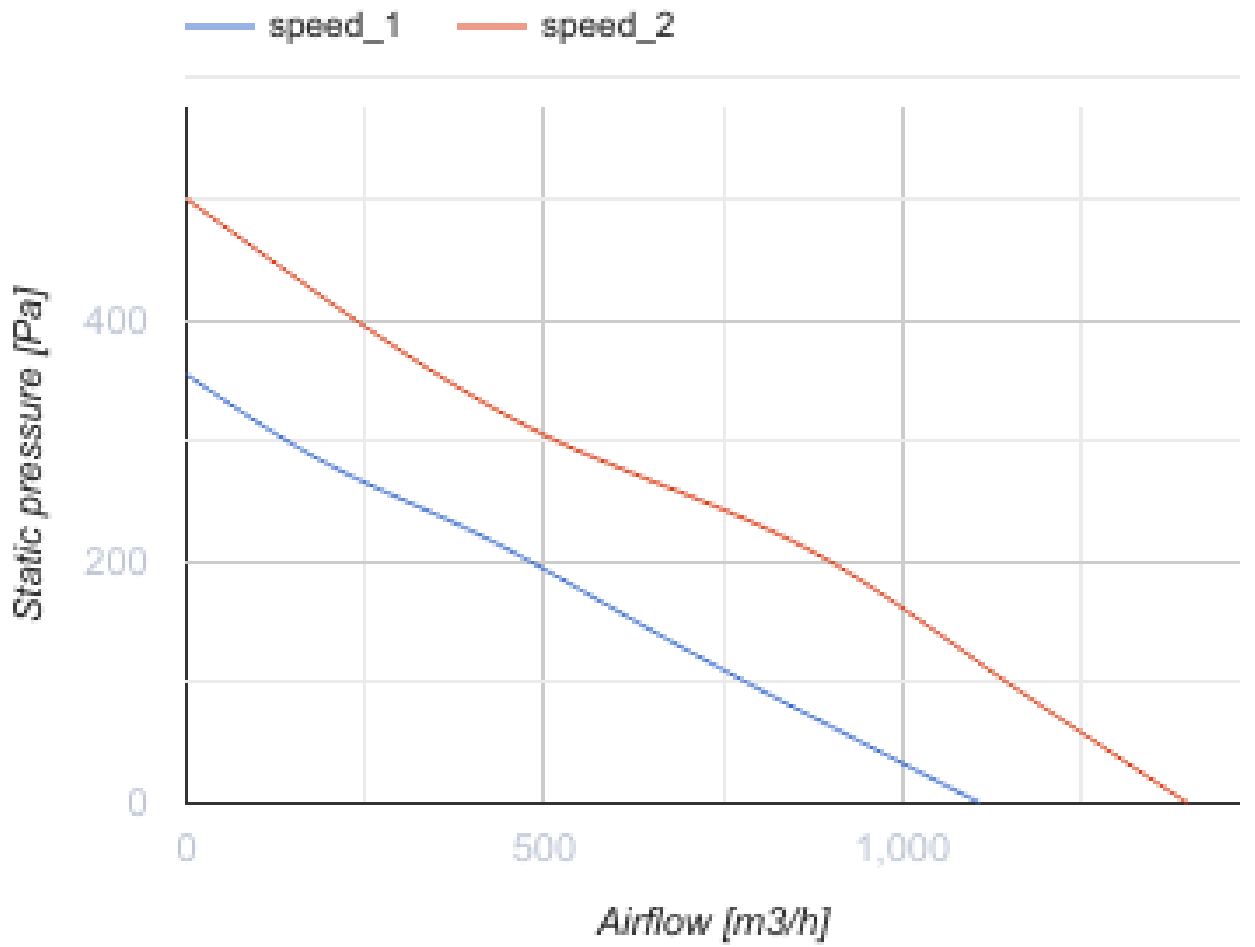

### Dimensions

ØD	B	B1	L	H
248	358	445	658	360

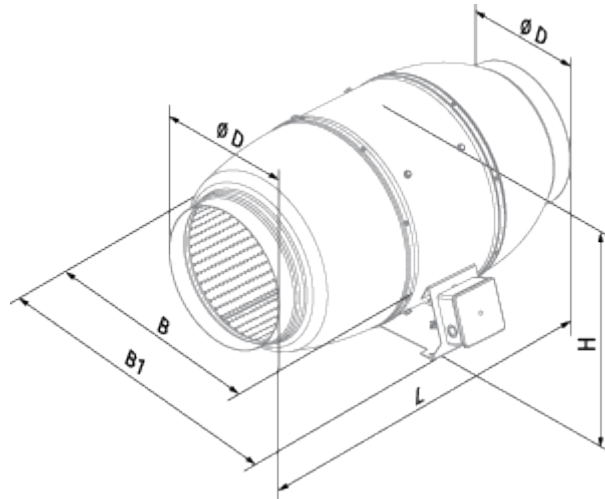





## Ecodesign

Trademark	Blauberg
Model	Iso-Mix 250 US
Type of ventilation unit	Unidirectional
Type of drive installed	External MSD or VSD
Type of heat recovery system	None
Nominal flow rate (m <sup>3</sup> /s)	0.223
Nominal external pressure (Pa)	236
Maximum external leakage rates (%)	2.7
Static efficiency (%)	30.9
Declared typology	NRVU UVU
Effective electric power input (kW)	0.174
Sound power level (dB(A))	56



## Accessories

### Other accessories



Name	Photo	Description
<a href="#">CDP-2/5</a>		Multi-speed switch
<a href="#">CDT E1.8</a>		Thyristor speed controller
<a href="#">CDP-2/10</a>		Multi-speed switch
<a href="#">CDT1 E1.5</a>		Multi-speed switches

### Other accessories





Name	Photo	Description
<a href="#">TE / TI 1.5</a>		Timers

<a href="#">HSE / HSI 1.5</a>		Sensors
<a href="#">LSE / LSI 1.5</a>		Sensors
<a href="#">IRSE / IRSI 1.5</a>		Sensors

### Other accessories









Name	Photo	Description
<a href="#">SD 250/1200</a>		Silencers for round ducts
<a href="#">SD 250/900</a>		Silencers for round ducts
<a href="#">SD 250/600</a>		Silencers for round ducts

### Other accessories

Name	Photo	Description
<a href="#">KFBK 250</a>		Filter boxes for round ducts
<a href="#">KFBT 250 G4</a>		Filter boxes with pocket filters for round ducts
<a href="#">KFBT 250 F5</a>		Filter boxes with pocket filters for round ducts
<a href="#">KFBT 250 F7</a>		Filter boxes with pocket filters for round ducts

### Other accessories

Name	Photo	Description
<a href="#">EKH 250-1.2</a>		Duct electrical heaters for round ducts

<a href="#">EKH 250-2.0</a>		Duct electrical heaters for round ducts
<a href="#">EKH 250-2.4</a>		Duct electrical heaters for round ducts
<a href="#">EKH 250-3.0</a>		Duct electrical heaters for round ducts
<a href="#">EKH 250-3.6</a>		Duct electrical heaters for round ducts
<a href="#">EKH 250-6.0</a>		Duct electrical heaters for round ducts
<a href="#">EKH 250-9.0</a>		Duct electrical heaters for round ducts
<a href="#">WKH 250-2</a>		Duct water heaters for round ducts
<a href="#">WKH 250-4</a>		Duct water heaters for round ducts

### Other accessories

Name	Photo	Description
<a href="#">VRV 250</a>		Backdraft dampers with spring for round ducts
<a href="#">VKA 250</a>		Air dampers for round ducts