

Iso-Mix 125

Mixed-flow inline fans in sound-insulated casings



- Maximum airflow: 347
- Sound pressure level LpA at 3 m: 28
- Sound insulation
- Motor type: AC
- Impeller type: Mixed-flow
- Casing material: Coated steel
- Installation in any position

	Unit of measurement	Iso-Mix 125	
Connected air duct size	mm	125	
Speed	-	2	
Phases	-	1	
Minimum supply voltage	V	230	
Maximum supply voltage	V	230	
Power supply frequency	Hz	50/60	
Rated power	W	25	29
Unit current	A	0.11	0.13
Maximum airflow	m ³ /h	235	347
Sound pressure level LpA at 3 m	dB(A)	23	28
Weight	kg	4.6	
Transported air temperature (max)	°C	60	
Ingress protection rating	-	IPX4	
Ingress protection rating of the drive	-	IP44	

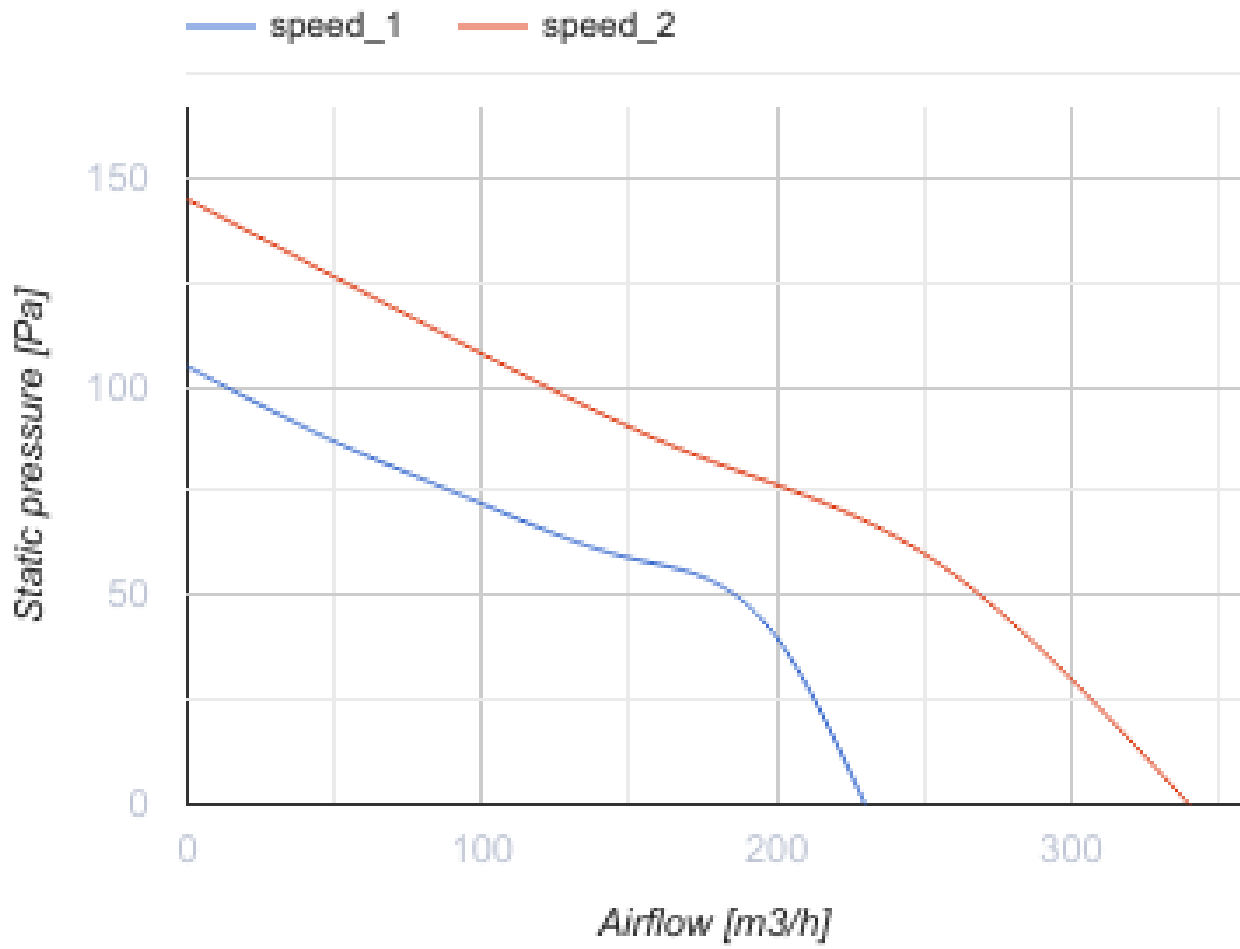

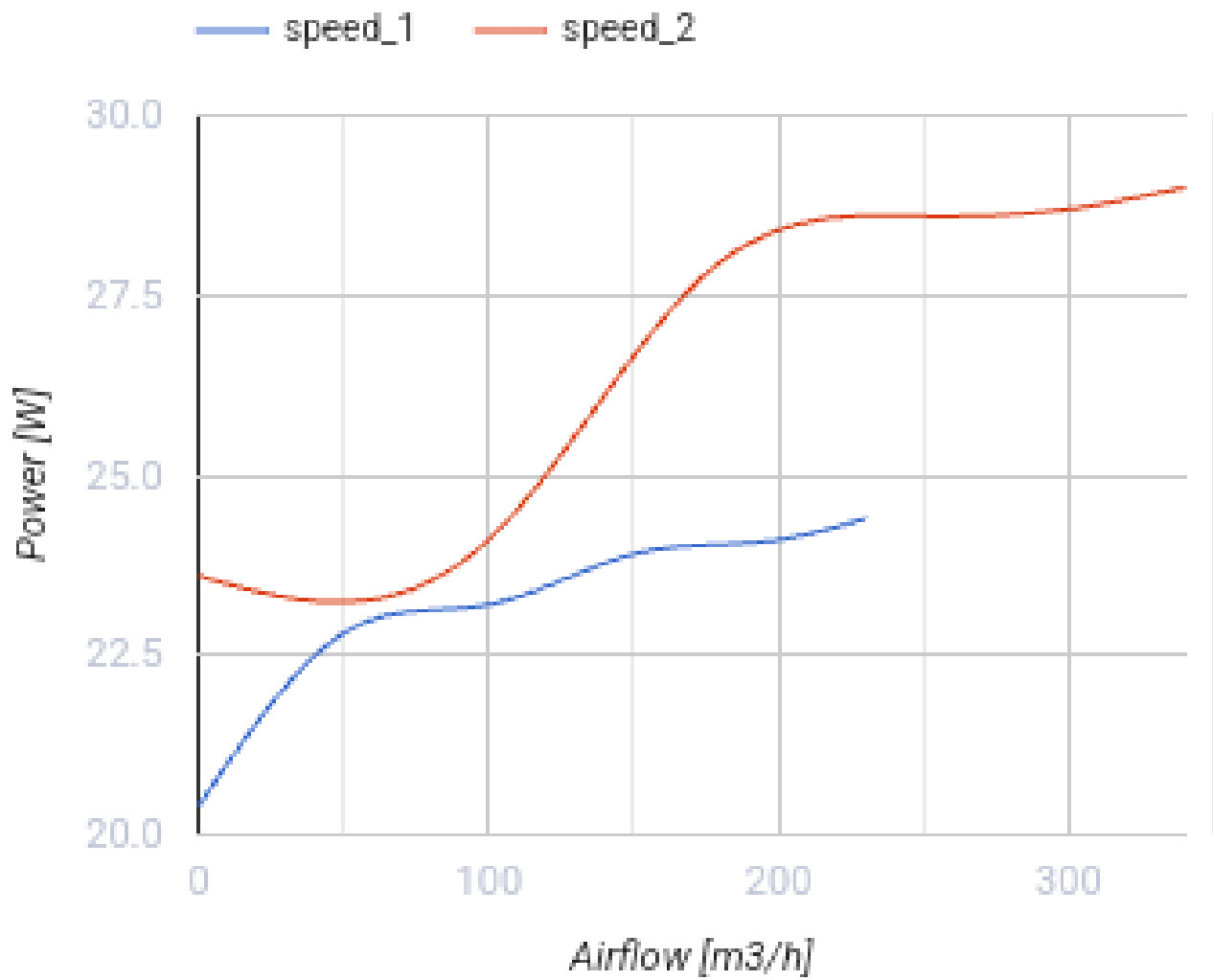

Dimensions

ØD	B	B1	L	H
123	214	243	474	251

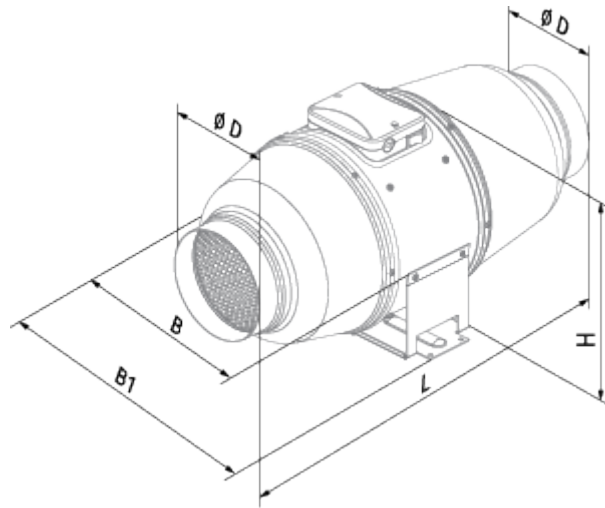

Ecodesign

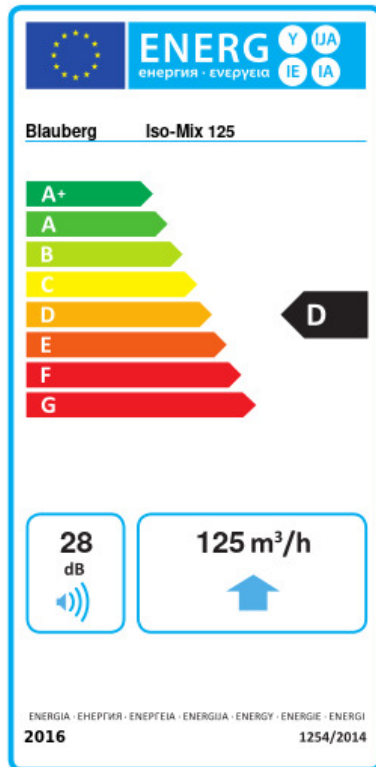

Trademark	Blaubeerg					
Model	Iso-Mix 125					
Specific energy consumption (SEC) (kWh/(m ² /a))	Cold		Average		Warm	
	-50	A+	-23	D	-7.5	F
Type of ventilation unit	Unidirectional					
Type of drive installed	Multi-speed					
Type of heat recovery system	None					
Maximum flow rate (m ³ /h)	125					
Electric power input (W)	29					
Reference flow rate (m ³ /s)	0.024					
Reference pressure difference (Pa)	50					
Specific power input (SPI) (W/(m ³ /h))	0.286					
Control typology	Local demand control					
Maximum external leakage rates (%)	2.7					
Declared typology	RVU UVU					
Sound power level (dB(A))	28					
The annual electricity consumption (AEC) (kWh/a)	Cold		Average		Warm	
	213		213		213	
The annual heating saved (AHS) (kWh/a)	Cold		Average		Warm	
	5536		2830		1280	





Accessories

Other accessories







Name	Photo	Description
CDP-2/5		Multi-speed switch
CDT E1.8		Thyristor speed controller
CDP-2/10		Multi-speed switch

CDT1 E0.5		Multi-speed switches
---------------------------	---	----------------------





Other accessories

Name	Photo	Description
TE / TI 1.5		Timers
HSE / HSI 1.5		Sensors
LSE / LSI 1.5		Sensors
IRSE / IRSI 1.5		Sensors



Other accessories

Name	Photo	Description
EKH 125-0.8		Duct electrical heaters for round ducts
EKH 125-0.6		Duct electrical heaters for round ducts
EKH 125-1.2		Duct electrical heaters for round ducts
EKH 125-1.6		Duct electrical heaters for round ducts
EKH 125-2.4		Duct electrical heaters for round ducts
WKH 125-2		Duct water heaters for round ducts
WKH 125-4		Duct water heaters for round ducts

Other accessories

Name	Photo	Description
KFBT 125 F7		Filter boxes with pocket filters for round ducts
KFBT 125 F5		Filter boxes with pocket filters for round ducts
KFBT 125 G4		Filter boxes with pocket filters for round ducts
KFBK 125		Filter boxes for round ducts

Other accessories

Name	Photo	Description
SD 125/1200		Silencers for round ducts
SD 125/900		Silencers for round ducts
SD 125/600		Silencers for round ducts

Other accessories

Name	Photo	Description
VRV 125		Backdraft dampers with spring for round ducts
VKA 125		Air dampers for round ducts