

Iso-Mix 100

Mixed-flow inline fans in sound-insulated casings



- Maximum airflow: 233
- Sound pressure level LpA at 3 m: 29
- Sound insulation
- Motor type: AC
- Impeller type: Mixed-flow
- Casing material: Coated steel
- Installation in any position

	Unit of measurement	Iso-Mix 100	
Connected air duct size	mm	100	
Speed	-	2	
Phases	-	1	
Minimum supply voltage	V	230	
Maximum supply voltage	V	230	
Power supply frequency	Hz	50/60	
Rated power	W	24	26
Unit current	A	0.1	0.11
Maximum airflow	m ³ /h	175	233
Sound pressure level LpA at 3 m	dB(A)	24	29
Weight	kg	4.6	
Transported air temperature (max)	°C	60	
Ingress protection rating	-	IPX4	
Ingress protection rating of the drive	-	IP44	

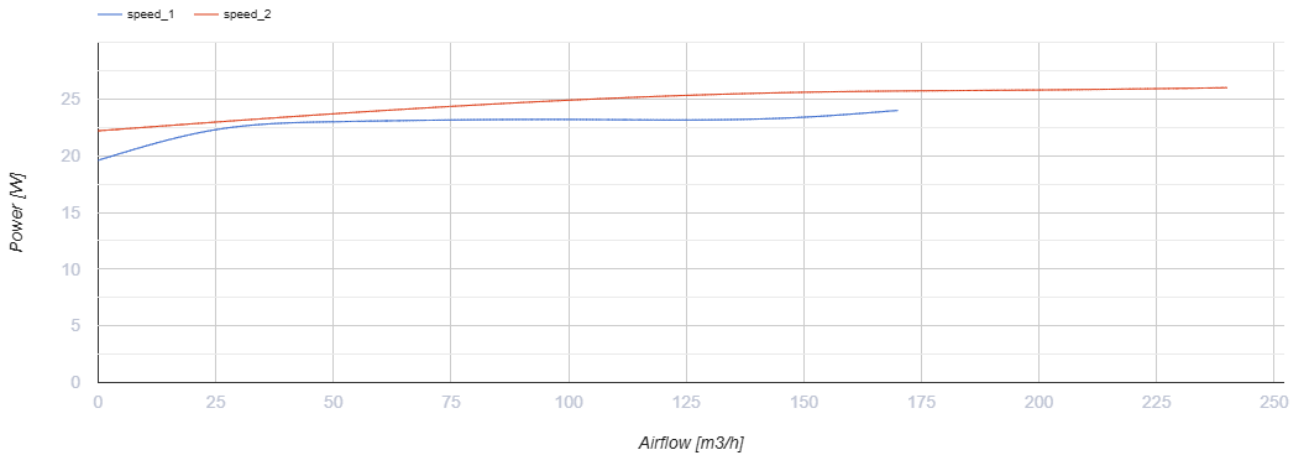
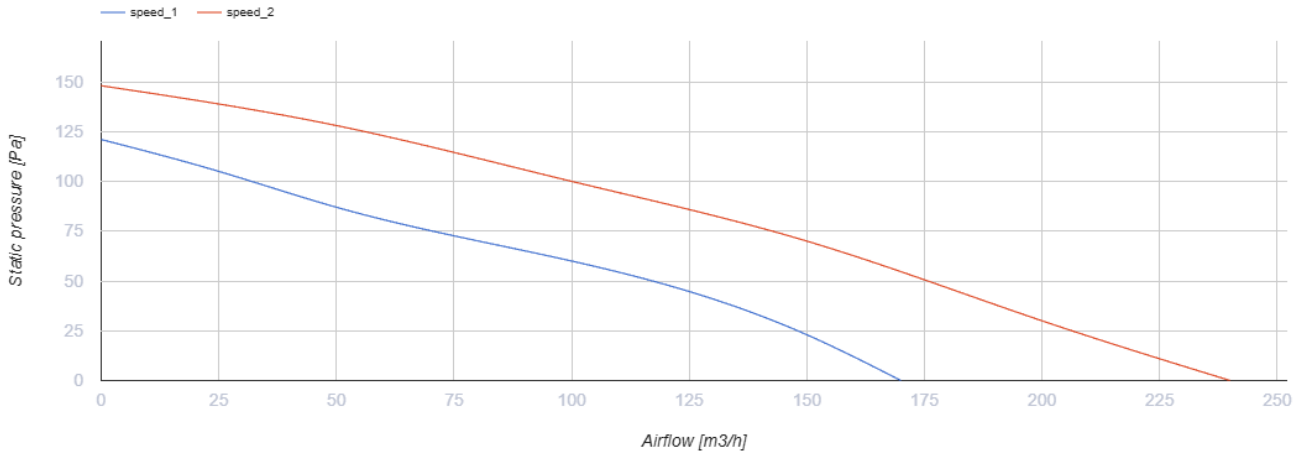

Dimensions

ØD	B	B1	L	H
98	214	243	505	251

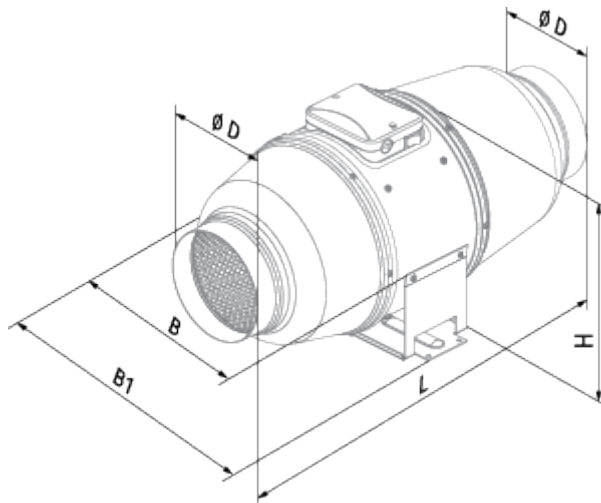

Ecodesign

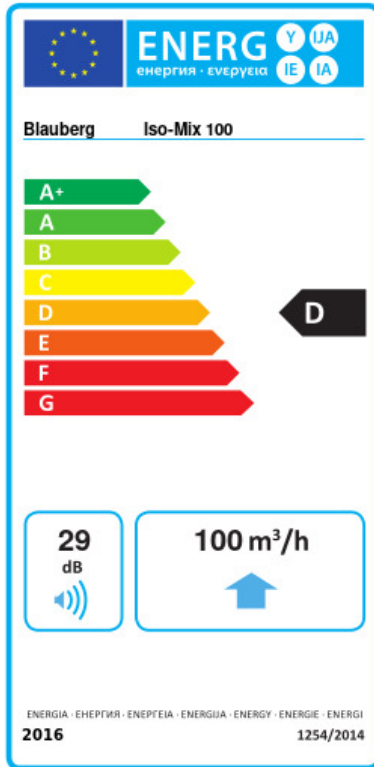

Trademark	Blaubeerg		
Model	Iso-Mix 100		
Specific energy consumption (SEC) (kWh/(m ² /a))	Cold	Average	Warm
	-49 A+	-21.9 D	-6.4 F
Type of ventilation unit	Unidirectional		
Type of drive installed	Multi-speed		
Type of heat recovery system	None		
Maximum flow rate (m ³ /h)	100		
Electric power input (W)	26		
Reference flow rate (m ³ /s)	0.019		
Reference pressure difference (Pa)	50		
Specific power input (SPI) (W/(m ³ /h))	0.343		
Control typology	Local demand control		
Maximum external leakage rates (%)	2.7		
Declared typology	RVU UVU		
Sound power level (dB(A))	29		
The annual electricity consumption (AEC) (kWh/a)	Cold	Average	Warm
	256	256	256
The annual heating saved (AHS) (kWh/a)	Cold	Average	Warm
	5536	2830	1280





Accessories

Other accessories







Name	Photo	Description
CDP-2/5		Multi-speed switch
CDT E1.8		Thyristor speed controller
CDP-2/10		Multi-speed switch

CDT1 E0.5		Multi-speed switches
---------------------------	---	----------------------





Other accessories

Name	Photo	Description
TE / TI 1.5		Timers
HSE / HSI 1.5		Sensors
LSE / LSI 1.5		Sensors
IRSE / IRSI 1.5		Sensors



Other accessories

Name	Photo	Description
EKH 100-1.2		Duct electrical heaters for round ducts
EKH 100-0.8		Duct electrical heaters for round ducts
EKH 100-0.6		Duct electrical heaters for round ducts
EKH 100-1.6		Duct electrical heaters for round ducts
EKH 100-1.8		Duct electrical heaters for round ducts
WKH 100-2		Duct water heaters for round ducts
WKH 100-4		Duct water heaters for round ducts

Other accessories

Name	Photo	Description
KFBT 100 F7		Filter boxes with pocket filters for round ducts
KFBT 100 F5		Filter boxes with pocket filters for round ducts
KFBT 100 G4		Filter boxes with pocket filters for round ducts
KFBK 100		Filter boxes for round ducts

Other accessories

Name	Photo	Description
SD 100/1200		Silencers for round ducts
SD 100/900		Silencers for round ducts
SD 100/600		Silencers for round ducts

Other accessories

Name	Photo	Description
VRV 100		Backdraft dampers with spring for round ducts
VKA 100		Air dampers for round ducts