

Blaubox EC ME 400-3.3 S31

Supply ventilation units with an electric heater

- Power of electrical reheater: 3300
- Maximum airflow: 430
- Sound pressure level LpA at 3 m: 31
- Sound insulation
- Motor type: EC
- Reheater: Electric
- BMS protocol: ModBus
- Control: Wired control panel
- Casing material: Aluzinc steel

| | Unit of measurement | Blaubox EC ME 400-3.3 S31 |
|--|---------------------|---------------------------|
| Connected air duct size | mm | 200 |
| Phases | - | 3 |
| Minimum supply voltage | V | 400 |
| Maximum supply voltage | V | 400 |
| Power supply frequency | Hz | 50 |
| Rated power | W | 62 |
| Power of electrical reheater | W | 3300 |
| Unit current | A | 5.4 |
| Maximum airflow | m ³ /h | 430 |
| Sound pressure level LpA at 3 m | dB(A) | 31 |
| Weight | kg | 25 |
| Transported air temperature (max) | °C | 40 |
| Transported air temperature (min) | °C | -30 |
| Ambient air temperature min | °C | 1 |
| Ambient air temperature max | °C | 40 |
| Ambient air humidity max | % | 80 |
| Ingress protection rating | - | IP22 |
| Ingress protection rating of the drive | - | IP44 |

Dimensions

| D | H | L | L1 | L2 | W | W1 | W2 |
|-----|-----|-----|-----|-----|-----|-----|-----|
| 200 | 350 | 850 | 903 | 972 | 400 | 514 | 313 |

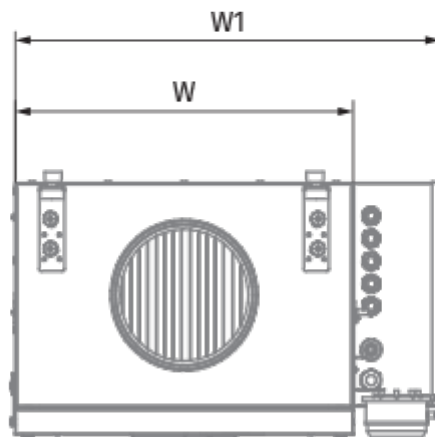
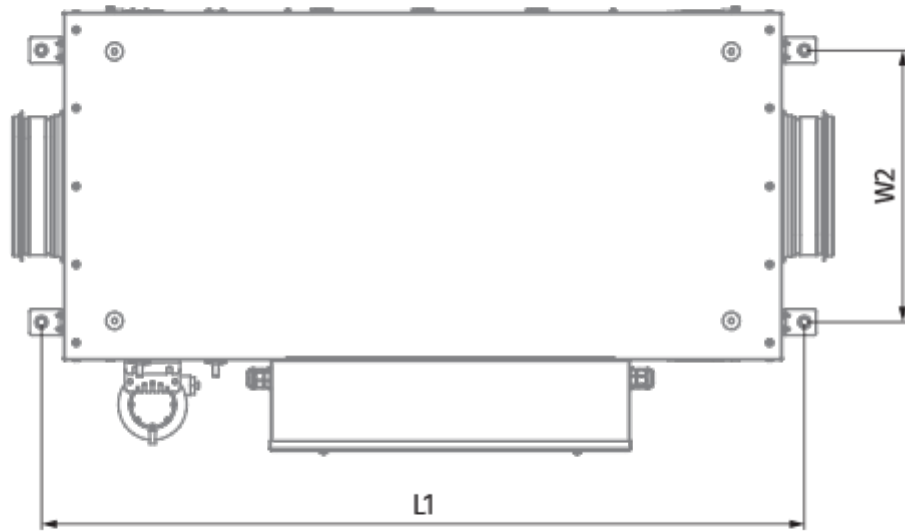
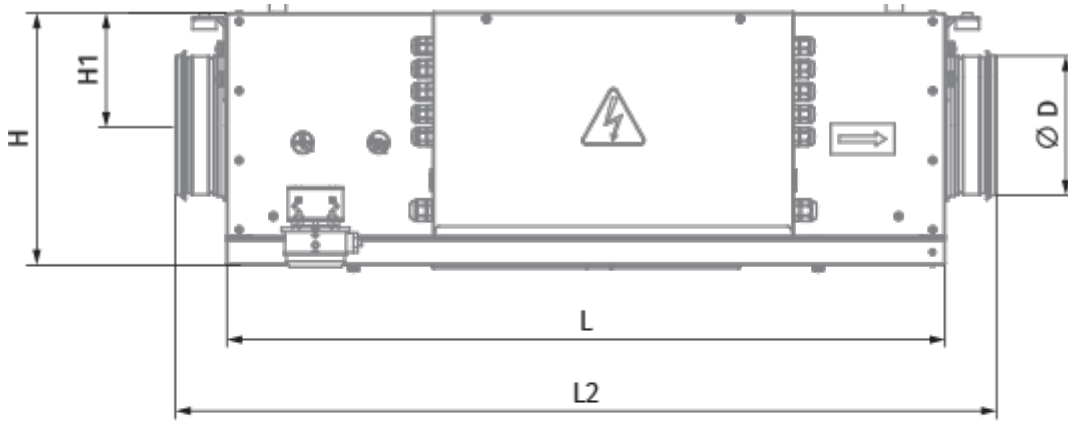

Ecodesign

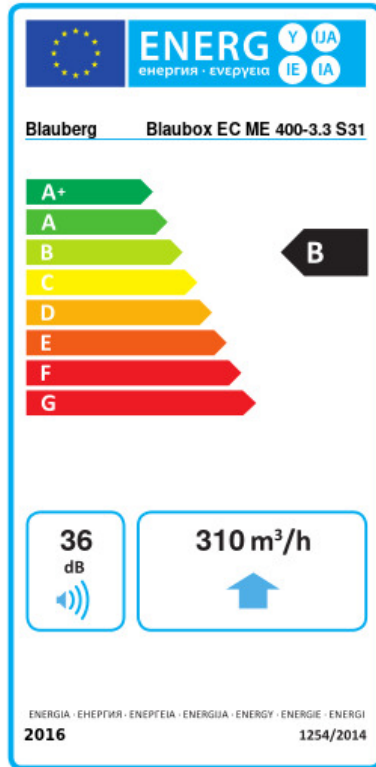

| | | | | | | |
|--|---------------------------|----|---------|---|------|---|
| Trademark | Blauberg | | | | | |
| Model | Blaubox EC ME 400-3.3 S31 | | | | | |
| Specific energy consumption (SEC) (kWh/(m²/a)) | Cold | | Average | | Warm | |
| | 54 | A+ | 26.9 | B | 11.4 | E |
| Type of ventilation unit | Unidirectional | | | | | |
| Type of drive installed | Variable speed | | | | | |
| Type of heat recovery system | None | | | | | |
| Maximum flow rate (m³/h) | 310 | | | | | |
| Electric power input (W) | 62 | | | | | |
| Reference flow rate (m³/s) | 0.061 | | | | | |
| Reference pressure difference (Pa) | 50 | | | | | |
| Specific power input (SPI) (W/(m³/h)) | 0.105 | | | | | |
| Control typology | Local demand control | | | | | |
| Maximum internal leakage rates (%) | 2.7 | | | | | |
| Maximum external leakage rates (%) | 2.7 | | | | | |
| Sound power level (dB(A)) | 36 | | | | | |
| Declared typology | RVU UVU | | | | | |
| The annual electricity consumption (AEC) (kWh/a) | Cold | | Average | | Warm | |
| | 55 | | 55 | | 55 | |
| The annual heating saved (AHS) (kWh/a) | Cold | | Average | | Warm | |
| | 5536 | | 2830 | | 1280 | |



Accessories

Other accessories

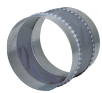

| Name | Photo | Description |
|-------------------------------|-------|-----------------|
| FP 334x287x48 Coarse 90% / G4 | | G4 panel filter |

| | | |
|-----------------------------|---|-----------------|
| FP 334x287x48 ePM1 70% / F7 |  | F7 panel filter |
|-----------------------------|---|-----------------|



Other accessories

| Name | Photo | Description |
|-------------------------|---|--|
| EVA 200 |  | Flexible anti-vibration connectors for round ducts |
| VKA 200 |  | Air dampers for round ducts |

Other accessories

| Name | Photo | Description |
|-----------------------------|---|---------------------------|
| SD 200/600 |  | Silencers for round ducts |
| SD 200/900 |  | Silencers for round ducts |
| SD 200/1200 |  | Silencers for round ducts |

Other accessories

| Name | Photo | Description |
|------------------------------|---|--------------------|
| Belimo TF24 |  | Electric actuators |
| Belimo TF230 |  | Electric actuators |