

# Blaubox EC ME 300-5.1 S31

Supply ventilation units with an electric heater

- Power of electrical reheater: 5100
- Maximum airflow: 354
- Sound pressure level LpA at 3 m: 35
- Sound insulation
- Motor type: EC
- Reheater: Electric
- BMS protocol: ModBus
- Control: Wired control panel
- Casing material: Aluzinc steel

	Unit of measurement	Blaubox EC ME 300-5.1 S31
Connected air duct size	mm	160
Phases	-	3
Minimum supply voltage	V	400
Maximum supply voltage	V	400
Power supply frequency	Hz	50
Rated power	W	64
Power of electrical reheater	W	5100
Unit current	A	7.4
Maximum airflow	m <sup>3</sup> /h	354
Sound pressure level LpA at 3 m	dB(A)	35
Weight	kg	24
Transported air temperature (max)	°C	40
Transported air temperature (min)	°C	-30
Ambient air temperature min	°C	1
Ambient air temperature max	°C	40
Ambient air humidity max	%	80
Ingress protection rating	-	IP22
Ingress protection rating of the drive	-	IP44

## Dimensions

D	H	L	L1	L2	W	W1	W2
160	290	850	903	950	400	514	313

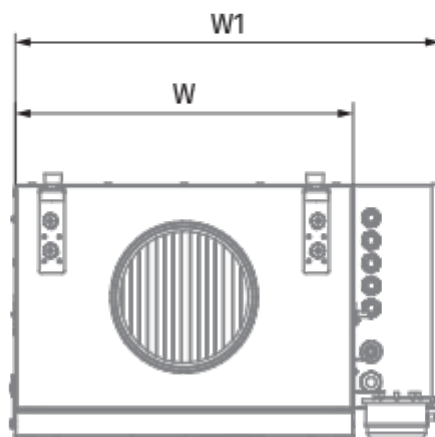
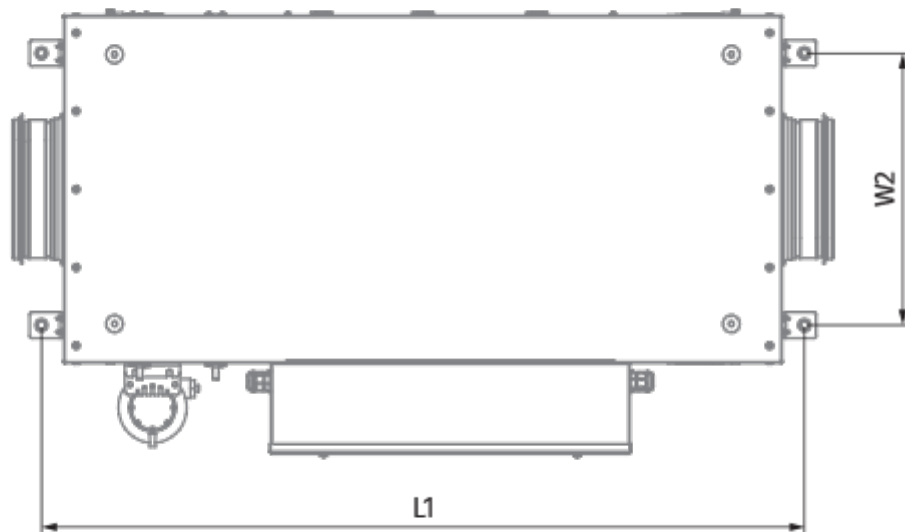
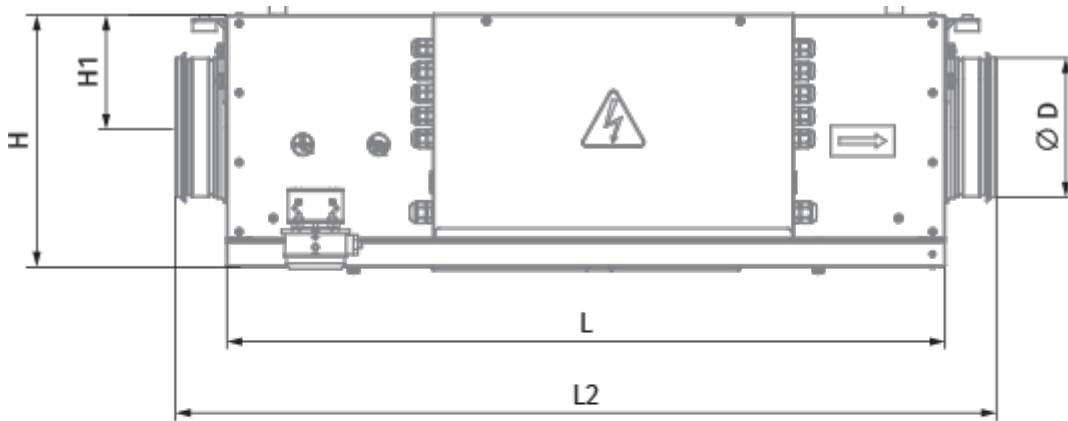

## Ecodesign

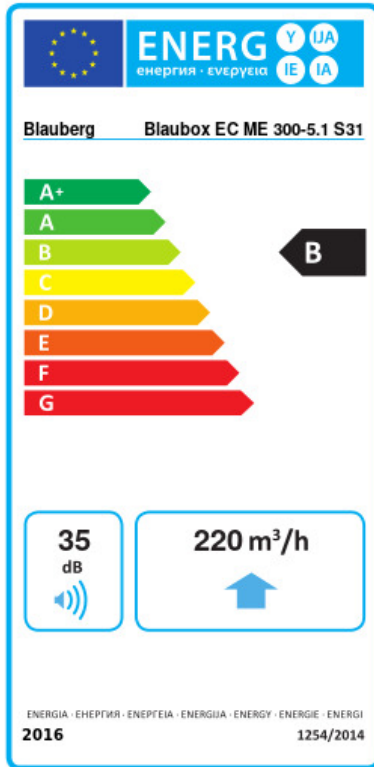

Trademark	Blauberg					
Model	Blaubox EC ME 300-5.1 S31					
Specific energy consumption (SEC) (kWh/(m²/a))	Cold		Average		Warm	
	53.9	A+	26.8	B	11.3	E
Type of ventilation unit	Unidirectional					
Type of drive installed	Variable speed					
Type of heat recovery system	None					
Maximum flow rate (m³/h)	220					
Electric power input (W)	64					
Reference flow rate (m³/s)	0.058					
Reference pressure difference (Pa)	50					
Specific power input (SPI) (W/(m³/h))	0.114					
Control typology	Local demand control					
Maximum internal leakage rates (%)	2.7					
Maximum external leakage rates (%)	2.7					
Sound power level (dB(A))	35					
Declared typology	RVU UVU					
The annual electricity consumption (AEC) (kWh/a)	Cold		Average		Warm	
	60		60		60	
The annual heating saved (AHS) (kWh/a)	Cold		Average		Warm	
	5536		2830		1280	



## Accessories

### Other accessories

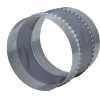

Name	Photo	Description
FP 334x226x48 Coarse 90% / G4		G4 panel filter

FP 334x226x48 ePM1 70% / F7		F7 panel filter
-----------------------------	-----------------------------------------------------------------------------------	-----------------



### Other accessories

Name	Photo	Description
<a href="#">EVA 125</a>		Flexible anti-vibration connectors for round ducts
<a href="#">VKA 125</a>		Air dampers for round ducts

### Other accessories

Name	Photo	Description
<a href="#">SD 125/600</a>		Silencers for round ducts
<a href="#">SD 125/900</a>		Silencers for round ducts
<a href="#">SD 125/1200</a>		Silencers for round ducts

### Other accessories

Name	Photo	Description
<a href="#">Belimo TF24</a>		Electric actuators
<a href="#">Belimo TF230</a>		Electric actuators