



Axis-Q 630 4E

Axial wall fans

- Maximum airflow: 11900
- Sound pressure level LpA at 3 m: 67
- Motor type: AC
- Impeller type: Axial
- Casing material: Coated steel
- Installation in any position

	Unit of measurement	Axis-Q 630 4E
Connected air duct size	mm	630
Speed	-	1
Minimum supply voltage	V	220
Maximum supply voltage	V	240
Power supply frequency	Hz	50/60
Rated power	W	750
Unit current	A	3.5
Maximum airflow	m ³ /h	11900
Sound pressure level LpA at 3 m	dB(A)	67
Weight	kg	20
Transported air temperature (max)	°C	60
Transported air temperature (min)	°C	-30
Ingress protection rating	-	IP24

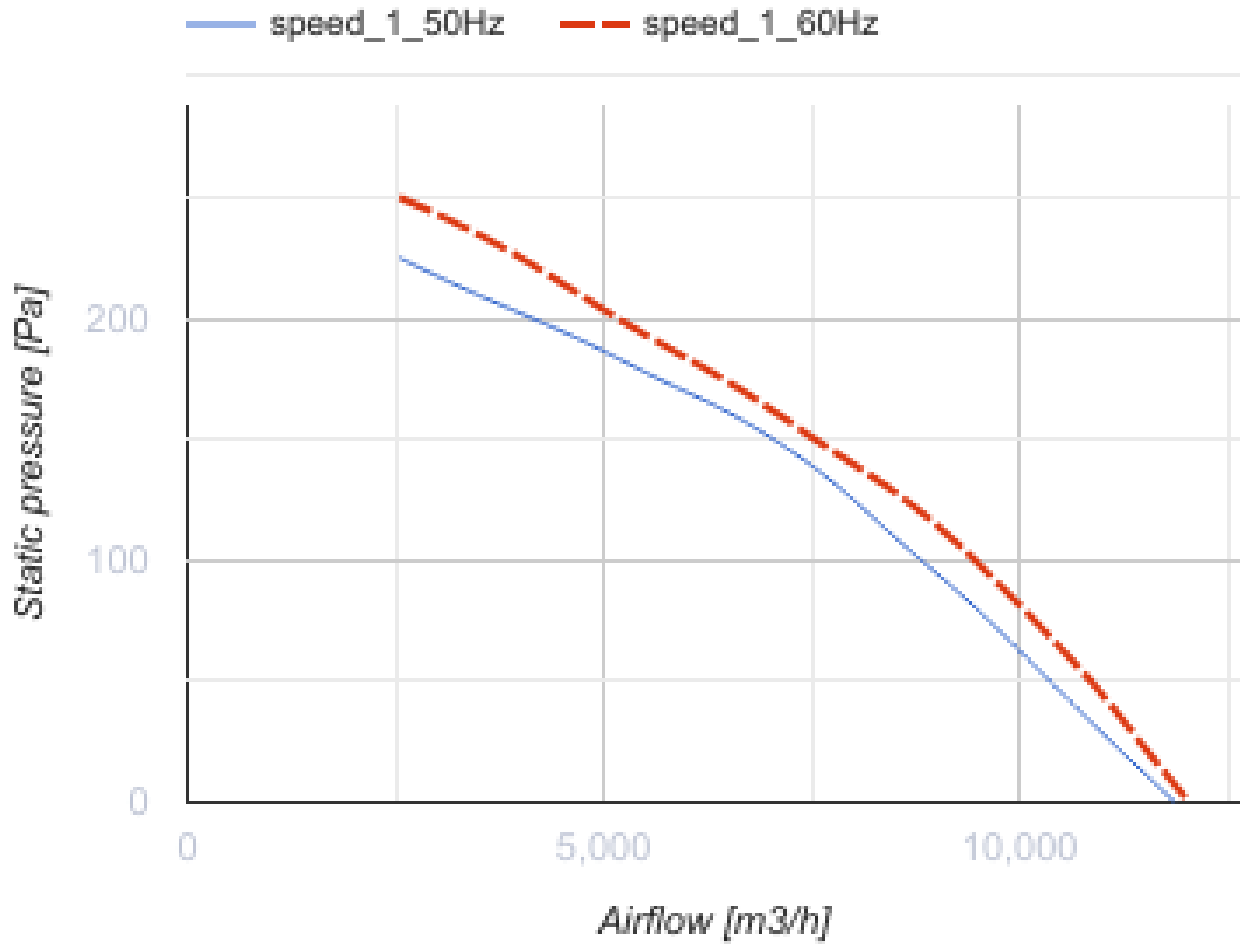

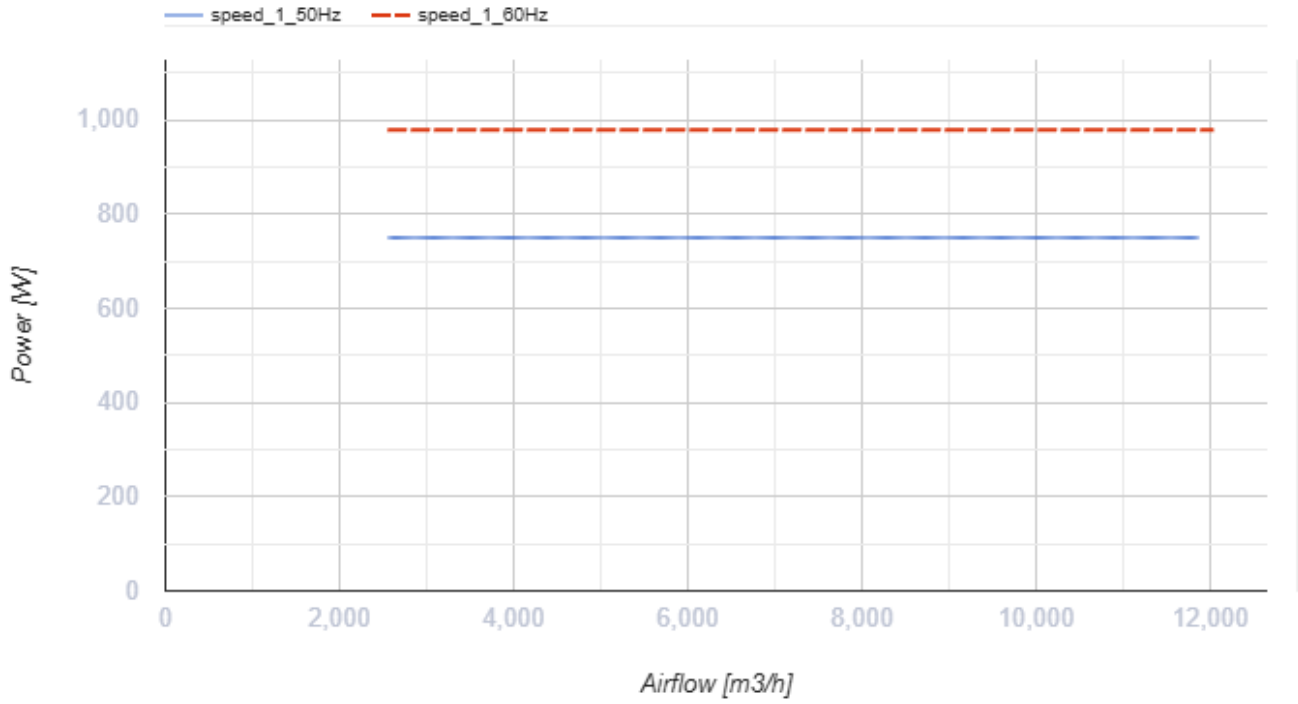

Dimensions

ØD	Ød	B	B1	L
650	11	800	710	275

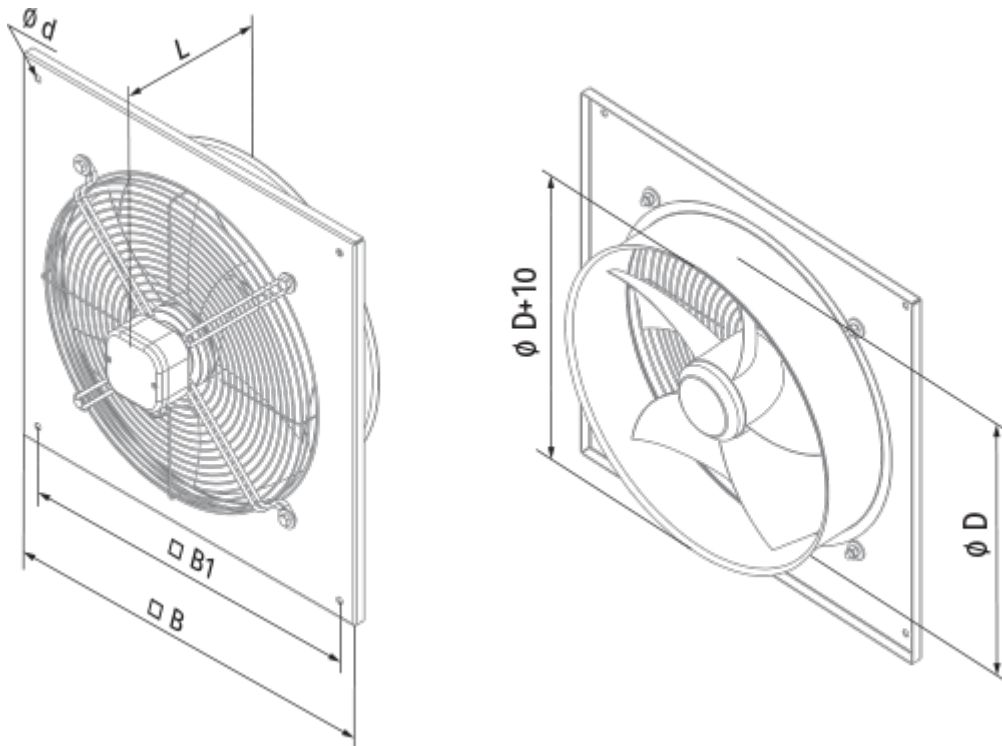

Ecodesign

Trademark	Blauberg
Model	Axis-Q 630 4E
Type of drive installed	External MSD or VSD
Type of heat recovery system	None
Nominal flow rate (m ³ /s)	1.971
Nominal external pressure (Pa)	149
Maximum external leakage rates (%)	2.7
Static efficiency (%)	37.5
Effective electric power input (kW)	0.8
Sound power level (dB(A))	95
Declared typology	NRVU UVU

Accessories

Other accessories

Name	Photo	Description
CDT E1.8		Thyristor speed controller