



## Axis-F 350 4D

Axial inline fans

- Maximum airflow: 2350
- Sound pressure level LpA at 3 m: 46
- Motor type: AC
- Impeller type: Axial
- Casing material: Coated steel
- Installation in any position

	Unit of measurement	Axis-F 350 4D
Connected air duct size	mm	350
Speed	-	1
Minimum supply voltage	V	400
Maximum supply voltage	V	400
Power supply frequency	Hz	50/60
Rated power	W	140
Unit current	A	0.38
Maximum airflow	m <sup>3</sup> /h	2350
Sound pressure level LpA at 3 m	dB(A)	46
Weight	kg	7.7
Transported air temperature (max)	°C	60
Transported air temperature (min)	°C	-30
Ingress protection rating	-	IPX4

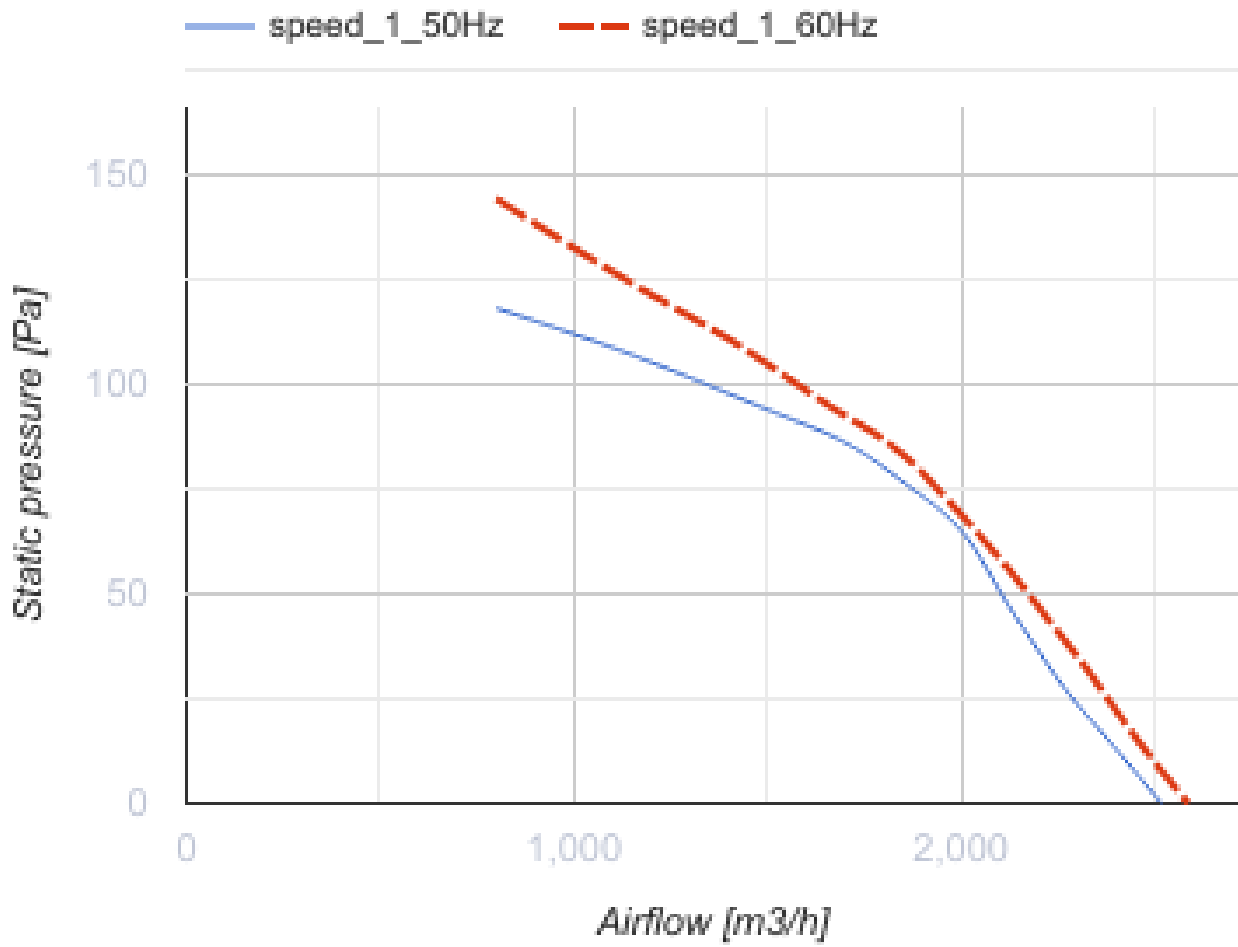

### Dimensions

ØD	ØD1	ØD2	Ød	B	L
362	395	421	9,5	450	160

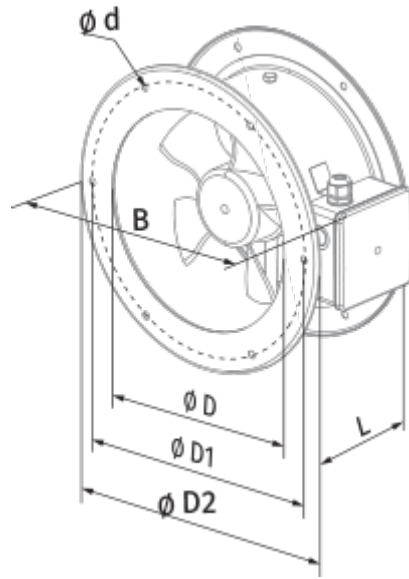

## Ecodesign

Trademark	Blauberg
Model	Axis-F 350 4D
Type of drive installed	External MSD or VSD
Type of heat recovery system	None
Nominal flow rate (m <sup>3</sup> /s)	0.501
Nominal external pressure (Pa)	80
Maximum external leakage rates (%)	2.7
Static efficiency (%)	31.7
Effective electric power input (kW)	0.129
Sound power level (dB(A))	82
Declared typology	NRVU UVU

## Accessories

### Other accessories

Name	Photo	Description
<a href="#">CDT E1.8</a>		Thyristor speed controller