

Smart

Smart IR

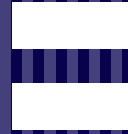

*model (check applicable)
is recognized as serviceable*

SMART

Service instruction



SALES DATE

MANUFACTURED ON (DATE):

SOLD

APPROVAL MARK

BLAUBERG Company is happy to offer your attention a new generation product, the BLAUBERG Smart fan. The solid team of high-qualified professionals with many years of working experience, technological innovations in design and production, high-quality components and materials from the top worldwide producers have become the precondition for the best fan in its class.

BLAUBERG Smart fan is the combination of design, high performance and silence operation multiplied by intelligence.

While you enjoy your rest, the BLAUBERG Smart guards your comfort. It is enough to connect it to power mains to have the ideal microclimate in your bathroom automatically maintained.

INTRODUCTION

The present service instruction contains a technical description, technical data sheets, operation and mounting guidelines, safety precautions and warnings for safe and correct operation of the fan BLAUBERG Smart.

USE

BLAUBERG Smart fan is designed for ventilation of humid residential and public premises heated during winter season.

The fan design is regularly improved, so some models can slightly differ from those ones described in this service instruction.

COMPLETE SET

The complete set includes:

fan - 1 item;

connecting piece with a back valve Ø 100 mm - 1 item;

connecting piece with a back valve Ø 125 mm - 1 item;

remote controller - 1 item;

screws and dowels - 4 items;

service instruction;

packing box.

BASIC CHARACTERISTICS

The fan designations, parameters, outer view, overall and connecting dimensions are shown in tables 1, 2, 3, 4 and in fig. 1, 2.

Voltage [V]	100-240
Frequency [Hz]	50-60
Max. power [W]	3,8
Current [A]	0,03
RPM [min-1]	2200
Max. air capacity [m³/h]	133
Ingress Protection Rating	IP 44
Weight [kg]	0,35

Table 1

Connecting piece diameter	Speed mode	Max. air capacity [m ³ /h]	Noise level, 3 m [dBA]	Air capacity, factory settings [m ³ /h]	Control range [m ³ /h]
100	24 Hours	33	17	33	
	Quiet	72	22	72	33 ... 72
	Maximal	106	31	82	72 ... 106
125	24 Hours	40	17	40	
	Quiet	83	21	83	40 ... 83
	Maximal	133	32	97	83 ... 133

Table 2

Type	Functions								
	Humidity control	24 Hours	Turn-on delay timer	Turn-off delay timer	Speed adjustment	Interval ventilation	External switch	Pause	Motion sensor
SMART	+	+	+	+	+	+	+	+	
SMART IR	+	+	+	+	+	+	+	+	+

Table 3

The fan has four basic modes and one extra mode:

SLEEP - in this mode the fan does not move and it is ready to accept a signal from the sensors or from the external switch.

24 Hours - the fan runs permanently with low speed and provides minimum air exchange in the room. After humidity changes the fan turns to MAXIMAL mode (by default) or QUIET mode.

After the motion sensor detects some movement in the room or after signal from the external sensor the fan turns to QUIET mode.

QUIET - optimal operation mode of the fan that ensures sufficient air capacity and low noise level. This mode is turned on after activation of the motion sensor, closing of the external switch or humidity level increase. For the humidity sensor this mode may be activated from the fan menu.

MAXIMAL - operation mode with maximum air capacity. It is turned on after humidity increase. This mode is activated for the humidity sensor by default.

INTERVAL VENTILATION - extra mode. After 15 hours standstill the fan is turned on to ventilate the room with air capacity 83/72m³/h (Ø125/Ø100) for 2 hours. If any sensor or the external switch is activated during interval ventilation mode, the fan will switch to the respective mode depending on the activated device.

Model	Dimensions [mm]				
	a	b	c	d	e
SMART/ SMART IR	155,5	209	28	100/125	28

Table 4

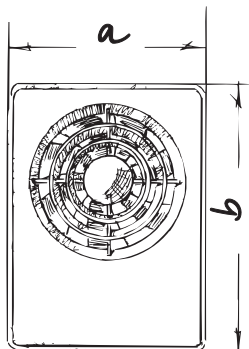
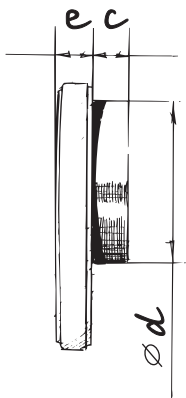

1

2

OPERATION RULES

The fan is rated for connection to single-phase ac 100-240 V / 50-60 Hz power supply and is designed for continuous operation always connected to power mains.

The fan is rated for operation at ambient temperature from +1 °C up to +45 °C.
The fan does not require grounding.

The fans do not cause interference with radio-, TV- or video- equipment.

Service life is not less than 5 years.

SAFETY RULES

All operations related to the fan electrical connections, servicing and repair works are allowed only after the fan disconnection from power mains.

All mounting and servicing operations are allowed for duly qualified electricians with valid electrical work permit for electric operations at the units up to 1000 V after careful study of the present user's manual.

The single-phase power grid must comply with the acting local electrical norms and standards. The fixed electrical wiring must be equipped with an automatic circuit breaker that is used for connection of the fan to power mains with gap on all poles at least 3 mm. Make sure the impeller and the casing are not damaged before starting installation.

The casing internals must be free of any foreign objects which can damage the impeller blades. Misuse of the product or any unauthorized modification are not allowed.

The product is not allowed for use by children and persons with reduced physical, mental or sensory capacities, without proper practical experience or expertise, unless they are controlled or instructed on the product operation by the person(s) responsible for their safety. Supervise the children and do not let them play with the product.

Take steps to prevent ingress of smoke, carbon monoxide and other combustion products into the room through open chimney flues or other fire-protection devices.

Sufficient air supply must be provided for proper combustion and exhaust of gases through the chimney of fuel burning equipment to prevent back drafting. The maximum permitted pressure difference per living units is 4 Pa.

Operating medium must not contain any dust or other solid impurities, sticky substances or fibrous materials.

The fan is not rated for operation in a media that contains hazardous or explosive materials and vapours, i.e. spirits, gasoline, insecticides, etc.

Do not close or block the fan intake or exhaust vent not to disturb the natural air passage. Do not sit on the fan and do not put objects on the fan.

Follow the guidelines of this service instructions to ensure durable operation of the product.

MOUNTING AND SETUP

Disconnect the fan from power mains prior to mounting and wireworks!

The fan is designed for wall mounting inside a round Ø 100 or 125 mm air duct or installation a the ventilation shaft.

Use a replaceable connecting piece of required diameter to facilitate mounting.

To prevent air backdraught from the air duct press the back valve on a replaceable connecting piece until click, fig. 7.

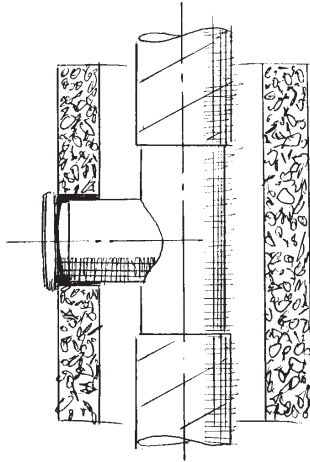

3

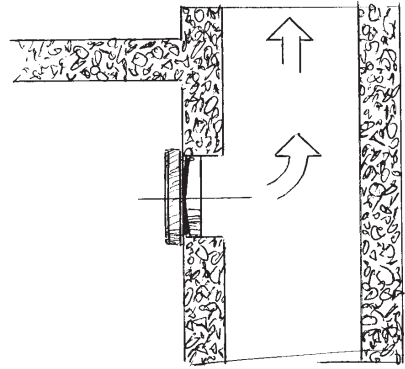

4

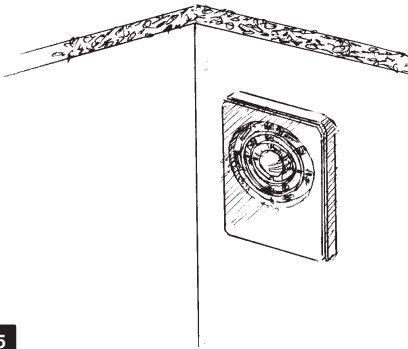

5

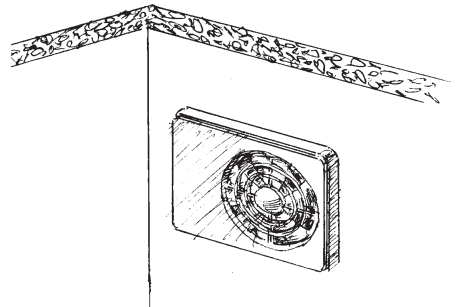

6

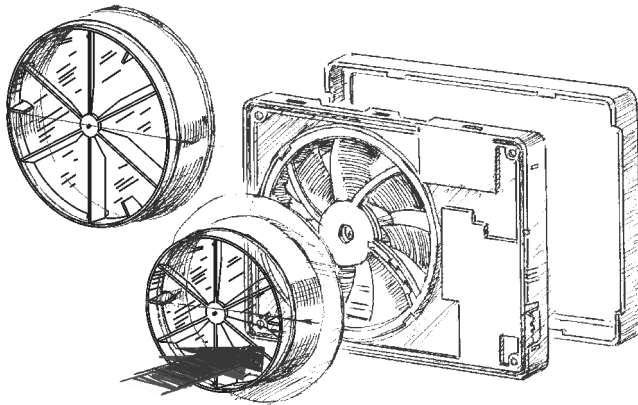

7

The fan is equipped with a removable grille.

To release the grille from the face cover press the latches gently.

During mounting of the grille on the face cover back match the latches and corresponding slots in the cover and insert to click. The arrow on the grille back side must be directed to the shorter side close to the hole.

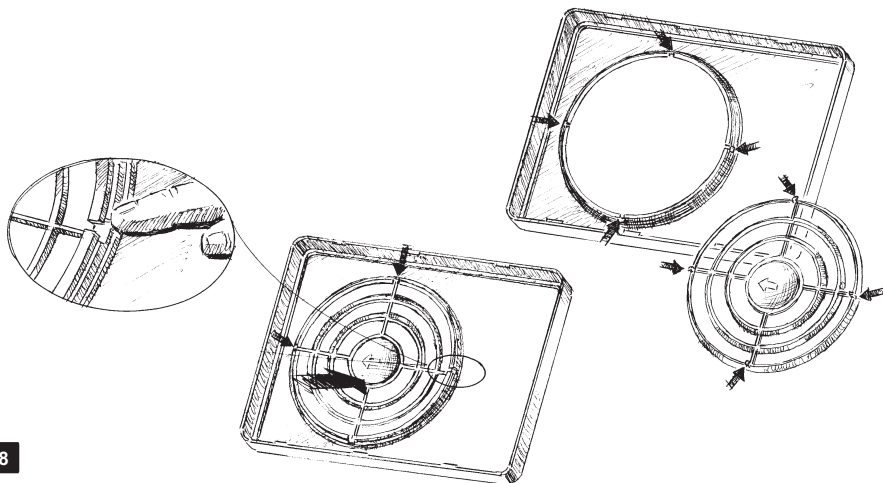

8

9

The fan casing has three round lowered tabs for cable entry.

Cut out a hole at the most suitable place with a knife.

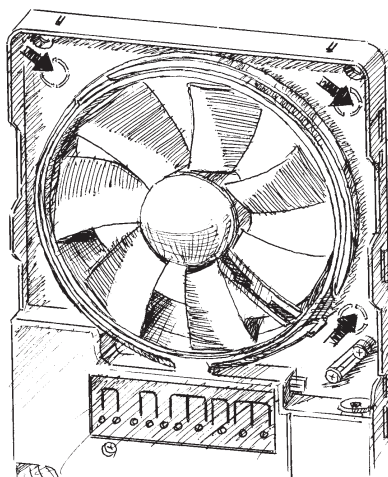

10

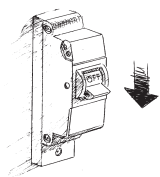

11

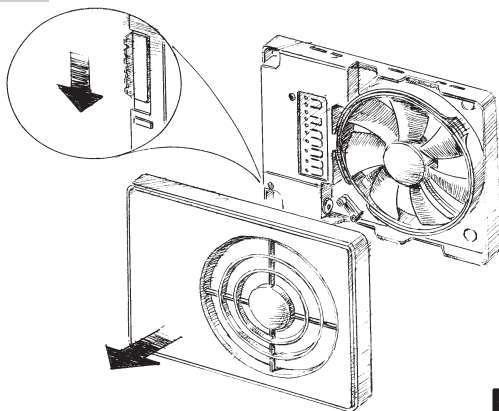

12

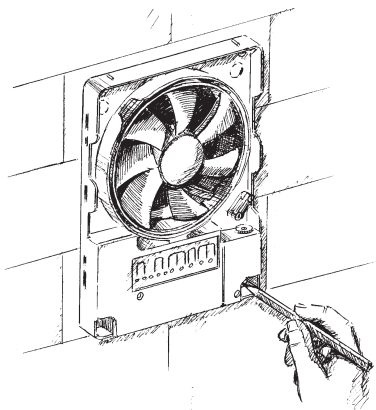

13

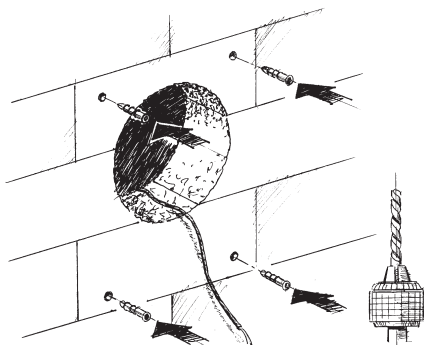

14

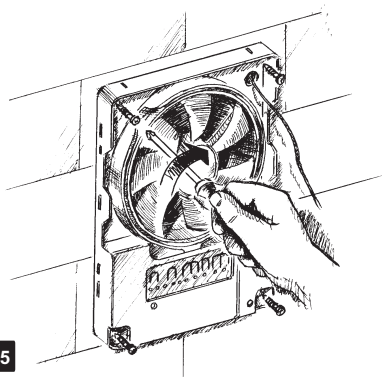

15

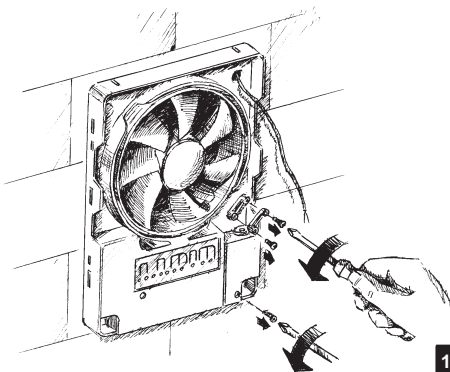

16

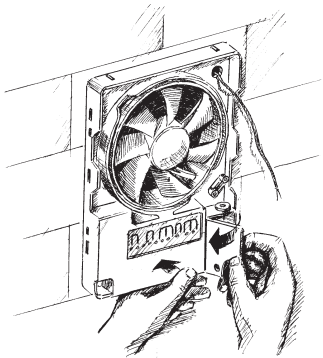

17

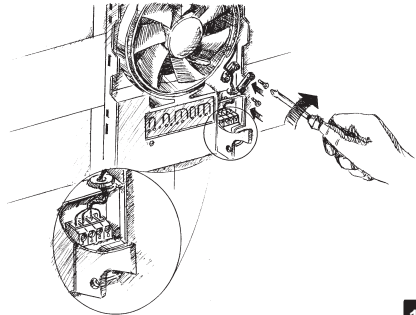

18

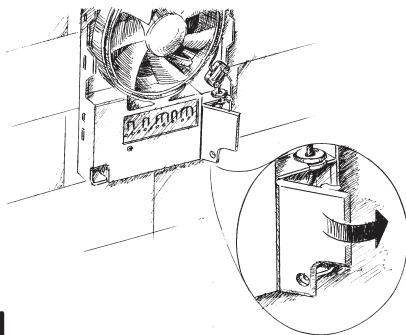

19

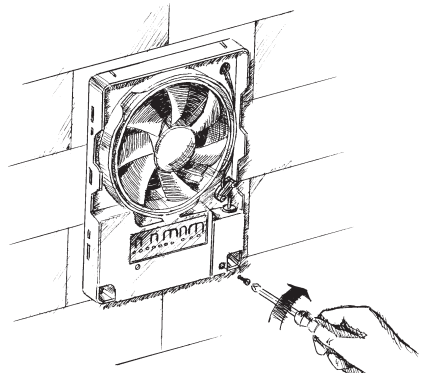

20

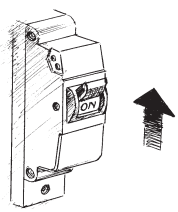

21

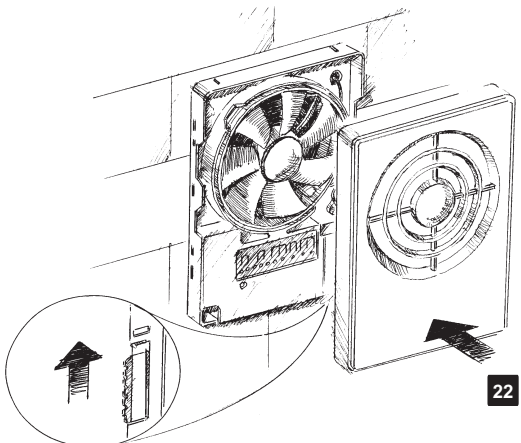

22

The fan is rated for connection to 100-240 V / 50-60 Hz power mains.
 Follow one of four available wiring diagrams to connect the fan to power mains.
 The model SMART IR is fitted with extra terminal LI that is used for connection of the light lamp up to 200 W/230 V or 100 W/130 V.
 The fan connected according to this wiring diagram will be switched on receipt of the signal from the motion sensor.

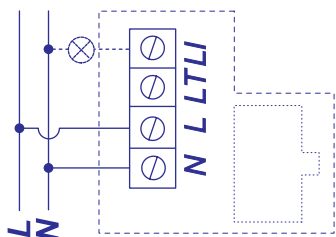

Wiring diagram 1

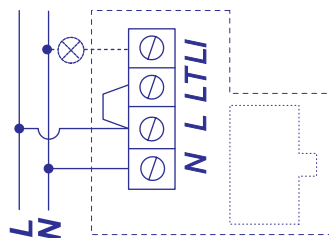

Wiring diagram 3

Wiring diagram 2

Wiring diagram 4

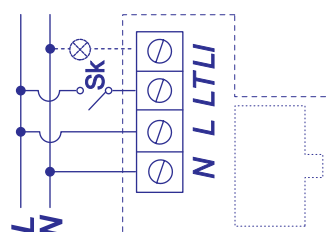
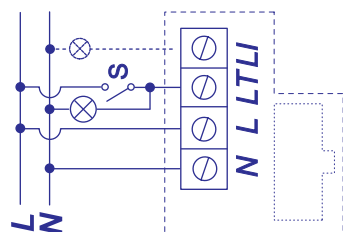

Wiring diagram 1

Automatic humidity and movement control (SMART IR).

The contacts L and N are connected to live and zero of power mains.

The fan is in SLEEP mode (does not run).

If 24 HOURS mode is activated, the fan switches to permanent low speed mode to provide minimum round-the-clock ventilation.

After receipt of a signal from the motion sensor (for SMART IR model only) the fan turns to QUIET mode. Some time after no movement is detected any more the fan reverts to the previous mode.

After humidity level increase the fan is turned to MAXIMAL mode (by default) or QUIET mode.

Some time after humidity drop the fan reverts to the previous mode.

Wiring diagram 2

Permanent fan operation with automatic humidity and movement control (SMART IR).

The contacts L and N are connected to live and zero of power mains and the contacts L and LT are bridged with a jumper.

The fan runs permanently at low speed.

24 HOURS mode is not available.

After receipt of a signal from the motion sensor (for SMART IR model only) the fan turns to QUIET mode. Some time after no movement is detected any more the fan reverts to the previous mode.

After humidity level increase the fan turns to MAXIMAL mode (by default) or QUIET mode.

Some time following the humidity drop the fan reverts to the previous mode.

Wiring diagram 3

Automatic humidity and movement control (SMART IR), timer and external switch.

The contacts L and N are connected to live and zero of power mains and the contact LT is connected to live through an external switch, for example, the lighting switch.

The fan is in SLEEP mode (does not run).

If 24 HOURS mode is activated the fan switches to permanent low speed mode to provide minimum round-the-clock ventilation.

After receipt of a signal from the motion sensor (for SMART IR model only) the fan is turned to QUIET mode. Some time after no movement is detected any more the fan reverts to the previous mode.

After closing of the external sensor the fan is turned to QUIET mode. Some time after the external switch is opened the fan reverts to the previous mode.

After humidity increase the fan turns to MAXIMAL (by default) or QUIET mode.

Some time after humidity drop the fan reverts to the previous mode.

Wiring diagram 4

Automatic humidity and movement control (SMART IR), timer and momentary switch.

The contacts L and N are connected to live and zero of power mains and the contact LT is connected to live through an external momentary switch, for example, door open sensor.

The fan is in SLEEP mode by default (does not run).

If 24 HOURS mode is activated the fan switches to permanent low speed mode to provide minimum round-the-clock ventilation.

After receipt of a signal from the motion sensor (for SMART IR model only) the fan is turned to QUIET mode. Some time after no movement is detected any more the fan reverts to the previous mode.

After short-term activation of the momentary switch the fan is turned to QUIET mode and operates in this mode for the time set by the turn-off timer. After that the timer reverts to the previous mode.

After humidity increase the fan turns to MAXIMAL (by default) or QUIET mode.

Some time after humidity drop the fan reverts to the previous mode.

OPERATING PATTERN - DIAGRAM 1

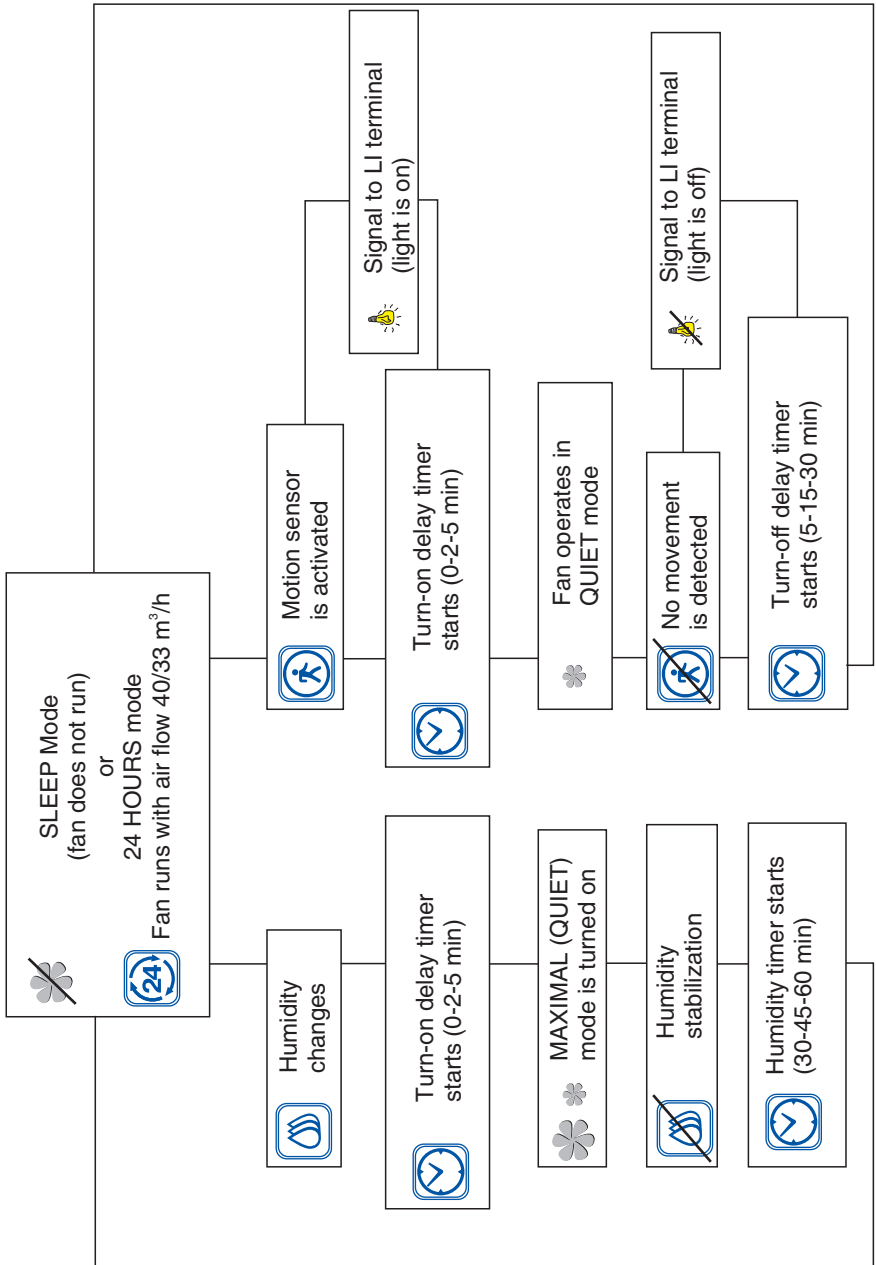

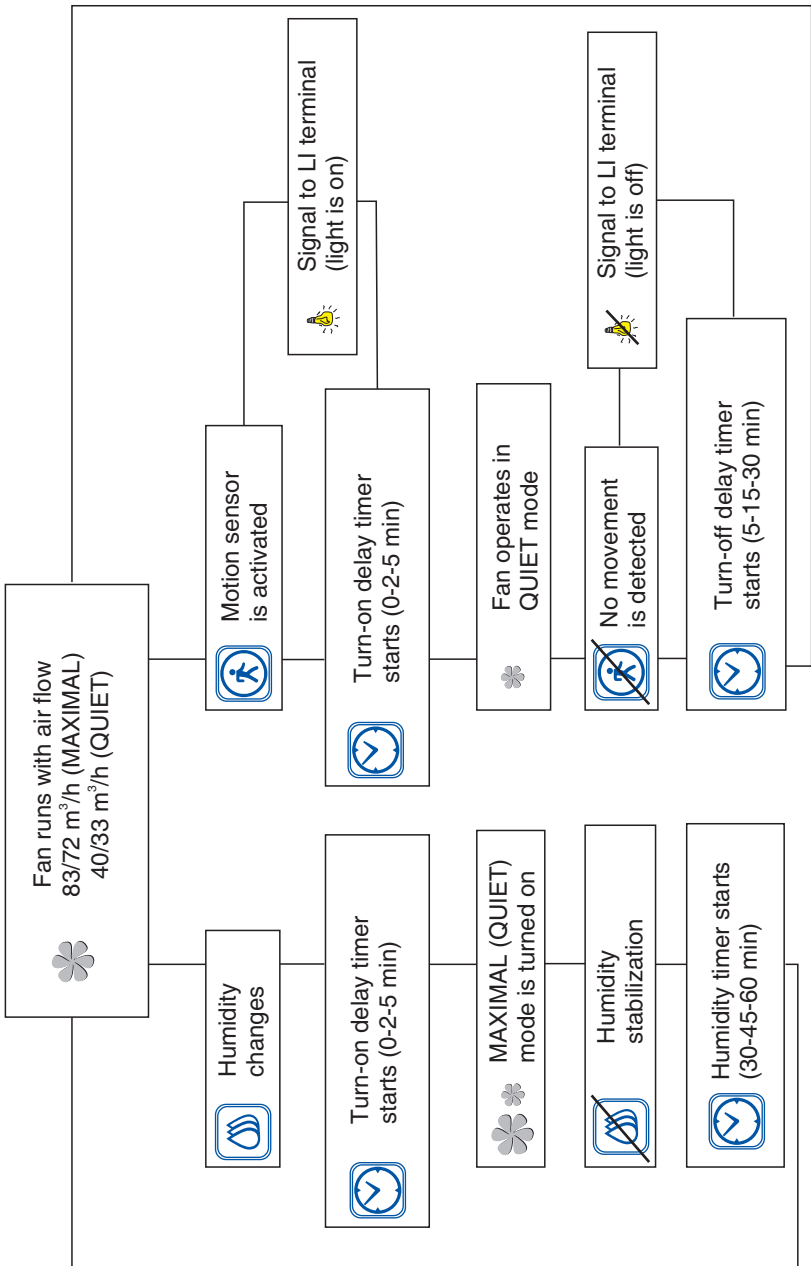

OPERATING PATTERN - DIAGRAM 3

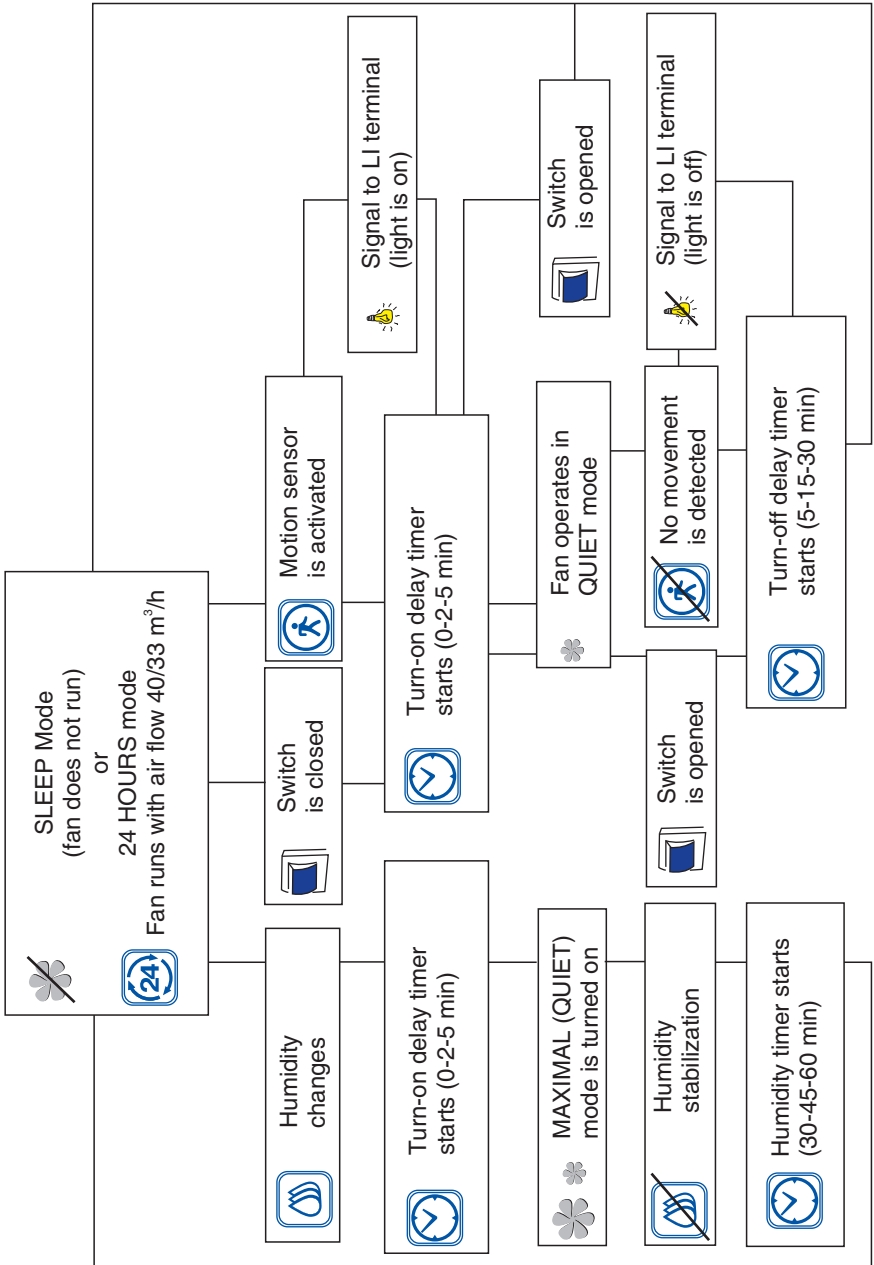

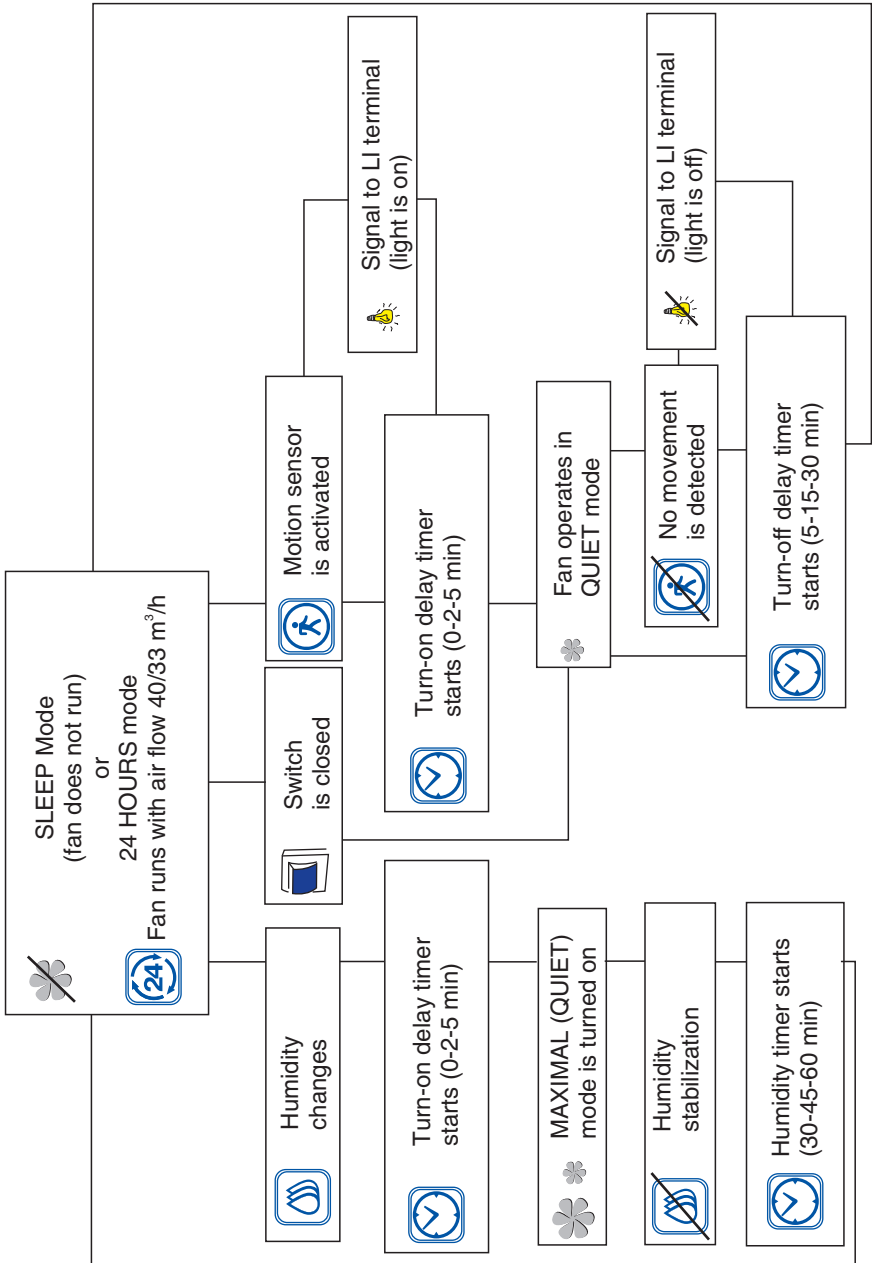

FAN ADJUSTMENT

The fan is adjusted at the factory and is ready for operation. It is a fully serviceable product that does not require compulsory adjustments. If you want to adjust the fan according to your needs, please follow the instruction below. In case of need you may reset to the factory settings.

FACTORY SETTINGS

SLEEP mode air capacity, m ³ /h	0
24 HOURS mode air capacity (Ø125 / Ø100), m ³ /h	40/33
QUIET mode air capacity (Ø125 / Ø100), m ³ /h	83/72
MAXIMAL mode air capacity (Ø125 / Ø100), m ³ /h	97/82
humidity extraction mode	MAXIMAL
turn-on delay timer settings, min	0
turn-off delay timer settings, min	5
humidity timer settings, min	30
Motion sensor (for model SMART IR only)	off
24 HOURS mode	off

Table 5

CONTROL PANEL

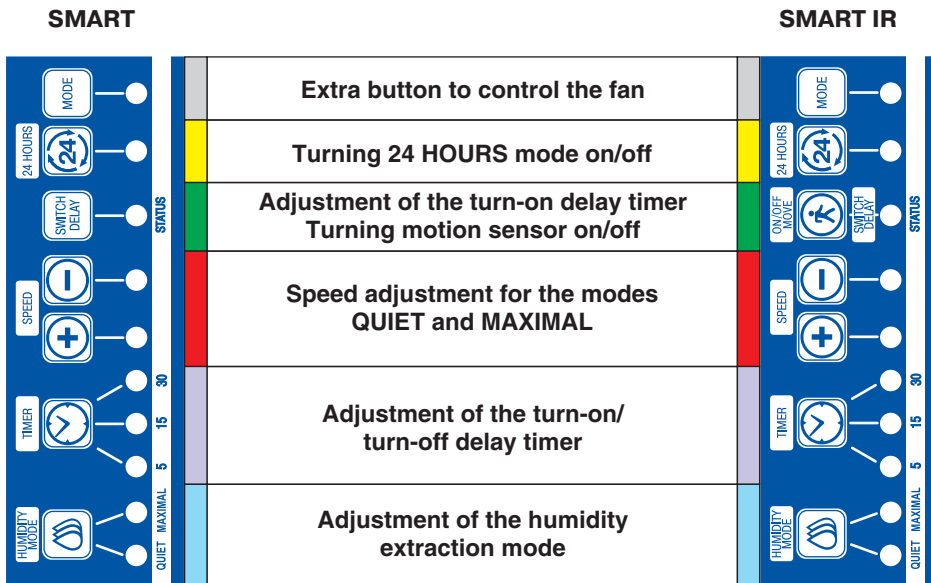

For your maximum comfort we equipped the fan with a remote infra-red remote controller. You may use the remote controller to adjust the fan.

The fan sends a sound signal each time after it receipt a signal from the remote controller to confirm setting adjustments.

If the fan sends no sound signal, press the button once again. If necessary decrease the distance to the fan.

ATTENTION! The maximum sensitive range of the remote controller is 3m. For easy control please direct the remote controller straight to the fan.

The temperature adjustment buttons "  " on the remote controller are not activated (applicable for the SMART THERMO model).









Button	Operation description
	Turning the fan on/off
	Quiet humidity extraction mode selection and Quiet speed adjustment
	Maximal humidity extraction mode selection and Maximal speed adjustment
	Turning the motion sensor on / off (Only for the model SMART IR)
	Turning Pause mode on/off
	Turning 24 HOURS mode on/off
	Adjustment of the turn-on delay timer for 0, 2 and 5 minutes respectively
	Adjustment of the turn-off delay timer for 5, 15 and 30 minutes respectively



Table 6

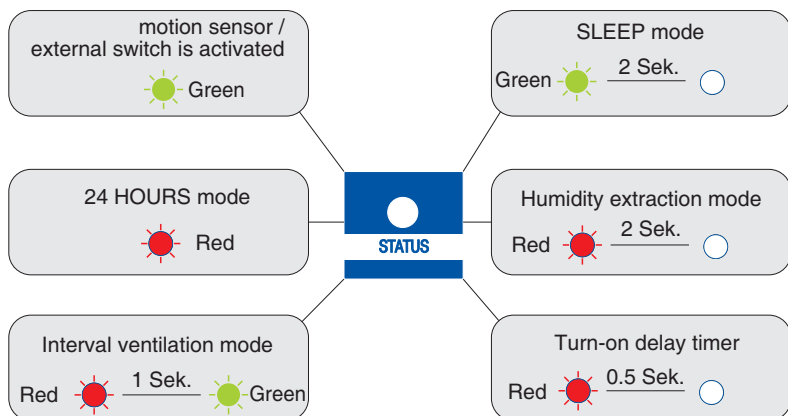

25

QUIET MODE SPEED ADJUSTMENT

By default this speed provides air capacity 83/72 m³/h (Ø125 / Ø100).

Speed adjustment:

On the control panel: press the button "+" to increase or the button "-" to decrease the fan speed.

On the remote controller: press the "▲" button to increase or the "▼" button to decrease the fan speed.

The buttons are located on the right side of the button **QUIET**.

To display the current air capacity press the button "+" or "-" once.

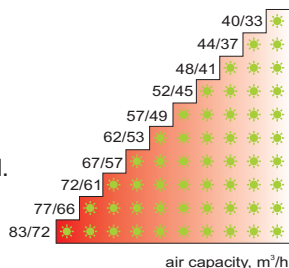

26

MAXIMAL MODE SPEED ADJUSTMENT

By default this speed provides an air capacity of 97/82 m³/h (Ø125 / Ø100).

Speed adjustment:

On the control panel: press and hold the button "MODE" then press the button "+" to increase or the button "-" to decrease the fan speed.

On the remote controller: press the button "▲" to increase or the button "▼" to decrease the fan speed.

The buttons are located on the right side of the button **MAXIMAL**.

MAXIMAL.

To display the current air capacity, press and hold the button "MODE", then press the button "+" to increase or the button "-" to decrease the air capacity.

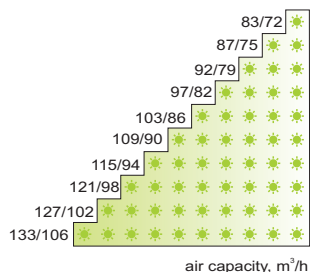

27

SELECTION OF HUMIDITY EXTRACTION MODE

If humidity changes the fan is turned on to higher speed to remove excessive humidity. After humidity stabilization in the room the humidity timer is activated and the fan runs within time period set by the humidity extraction timer and then reverts to the previous mode. To select the humidity extraction mode, press the "HUMIDITY MODE" button on the control panel or the "QUIET" and "MAXIMAL" buttons on the remote controller. To display the current mode, press the "HUMIDITY MODE" button once.

Note: Stabilization of the humidity is understood as change of humidity level not more than by 3% within 5 minutes.

MAXIMAL

Humidity-response mode with the impeller speed that ensures the best air capacity. This mode is recommended for the bathrooms above 6 m².



QUIET

Humidity-response mode with the impeller speed providing silent fan operation. This mode is recommended for small bathrooms.



28

HUMIDITY TIMER ADJUSTMENT

After humidity stabilization the fan continues operating some time at higher speed for total humidity removal. This timer is adjustable for 30, 45 or 60 minutes. The default time is 30 minutes. If humidity changes less by 20% for 10 minutes the timers setting automatically drops to 15 min.



30 min



45 min



60 min

29

Humidity extraction timer adjustment:

On the control panel: press and hold the button "MODE", then press the button "TIMER".

On the remote controller is this adjustment not available.

To display the current humidity extraction timer settings, press and hold the button "MODE" and then press the button "TIMER" once.

ADJUSTMENT OF TURN-OFF DELAY TIMER

After activation of the motion sensor or external switch the fan operates some time period and then reverts to the previous mode.

Adjustment of the turn-off delay timer:

On the control panel: press the button "TIMER" and adjust the turn-off delay time for 5, 15 or 30 minutes. On the remote controller: press the buttons "5", "15" or "30" minutes respectively. To display the current turn-off delay timer settings, press the button "TIMER" on the control panel once.



5 min



15 min



30 min

30

ADJUSTMENT OF TURN-ON DELAY TIMER

If you have to use your bathroom often and shortly, you can adjust the turn-on delay timer to avoid the fan unnecessary switching. After humidity increases or after signal from the external switch/motion sensor, the fan switches to higher speed in some time period (0, 2 or 5 min).

Adjustment of the turn-on delay timer:

On the control panel: press and hold the button "SWITCH DELAY" and synchronously press the button "TIMER".

On the remote controller: press the buttons "0", "2", "5" respectively.

To display the current turn-on delay timer settings, press and hold the button

"SWITCH DELAY" and then press the button "TIMER" on the control panel once.



0 min



2 min



5 min

31

ACTIVATION OF MOTION SENSOR (SMART IR)

To turn the motion sensor on, press the "On/Off move" button on the control panel or the "  " button on the remote controller. The indicator light "STATUS" under this button confirms that the motion sensor is turned on. To display the current motion sensor settings, press the button "On/Off move" on the control panel once.



32

ACTIVATION OF MODE 24 HOURS

In this mode the fan runs with minimum air capacity before the humidity sensor, motion sensor or external switch is activated.

Press the "24 HOURS" button on the control panel or the "24" button on the remote controller to activate this function. The green indicator light under this button on the control panel confirms that this mode is activated.

Press the button "24 HOURS" once again to deactivate "24 HOURS" mode. This function is not available for the wiring diagram 2.



33

PAUSE

Press the button "PAUSE" on the remote controller if you want to stop the fan for 45 minutes. After the timer countdown the fan reverts to the previous operation mode.

Press the button "PAUSE" once again to cancel the pause mode.

This function is controllable only from the remote controller.

ACTIVATION / DEACTIVATION OF THE FAN

Press the button "⏻" on the remote controller to deactivate the fan. The light on the fan goes off and the fan does not response to any external factors as humidity change, motion or closing of the external switch.

The interval ventilation function remains active - in 15 hours the fan is switched to 2 hours to ventilate the premise.

This function is controllable only from the remote controller.

RESET TO FACTORY SETTINGS

A built-in manual power slide switch is located in the fan side panel.

Turn the fan off with the slide switch, press and keep the button "MODE" on the control panel and then turn the fan on again with the slide switch. After the fan is turned on, keep the button "MODE" about 5 seconds until the light indicator stops blinking green.

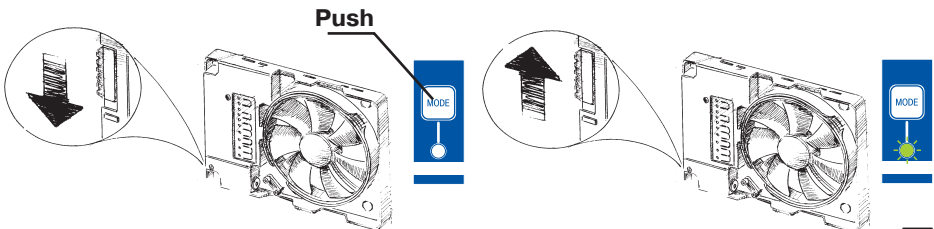

34

MAINTENANCE

Any servicing and maintenance operations of the fan are allowed after it is disconnected from power mains only. Maintenance means regular cleaning of the fan surfaces from dirt and dust.

To clean the fan, wipe its surfaces with a cloth wetted in a mild soap solution, then wipe the surfaces dry.

Avoid water dripping on the motor and circuit board!

The battery of the remote controller, model CR2025 3V, must be regularly replaced.

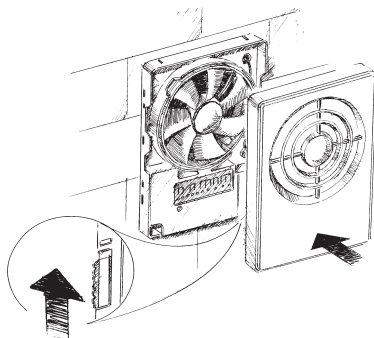
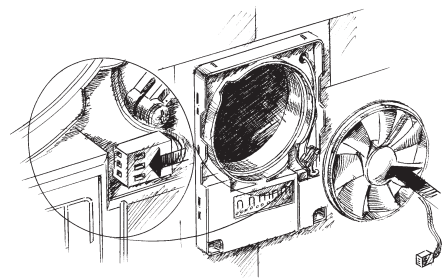
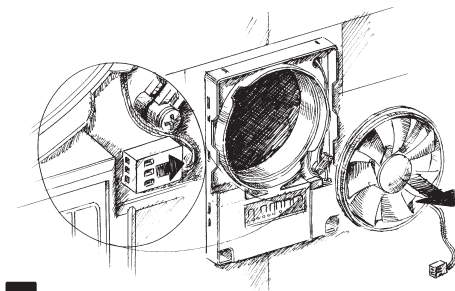
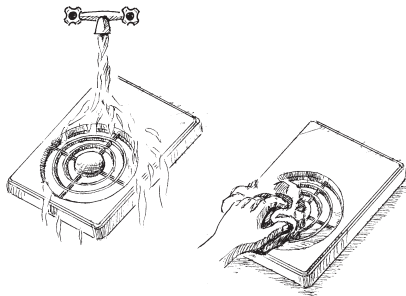
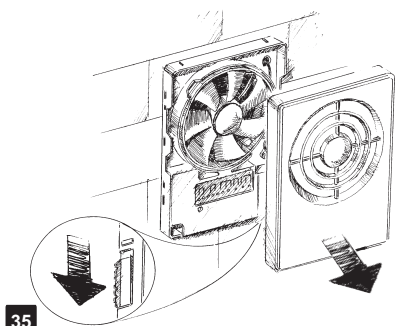

STORAGE AND TRANSPORTATION RULES

Transport the product in the manufacturer's original package.

Transportation is allowed by any transportation vehicle provided that the product is protected against weather influence.

Store the delivered product in the manufacturer's original packing box in a dry ventilated premise with the ambient temperature from +5°C up to + 40°C and relative humidity less than 80%.

The storage environment must be free of dust, acid or alkali vapours to prevent corrosion.

MANUFACTURER'S WARRANTY

The fan complies with the requirements according to the EU norms and directives, to the relevant EU-Low Voltage Equipment Directives, EU-Directives on Electromagnetic Compatibility.

We hereby declare that the following product complies with the essential protection requirements of Electromagnetic Council Directive 2004/108/EC, 89/336/EEC and Low Voltage Directive 2006/95/EC, 73/23/EEC and CE-marking Directive 93/68/EEC on the approximation of the laws of the Member States relating to electromagnetic compatibility. This certificate is issued following test carried out on samples of the product referred to above. Assessment of compliance of the product with the requirements relating to electromagnetic compatibility was based on the following standards.

Protection degree index according to IP rating against access to hazardous parts and water ingress - IP 44.

The manufacturer hereby ensures the steady fan operation within 5 years since the date of sale through the retail distribution network provided that transportation, storage, mounting and operation instructions are observed.

In case of failure due to manufacturing defects the during warranty period due to manufacturing defects, contact the seller for the product replacement.

In case of no proof of sales date the warranty period is calculated from the production date.

Replacements are offered by the Seller.

WARNING

The manufacturer is not responsible for any mechanical or physical damages resulting from the manual requirements violence, the unit misuse or gross mechanical effect. Follow the guidelines set forth in the user's manual for proper functioning of the fan.