



AIR TO WATER HEAT PUMPS

SPLIT TYPE

R32

2023

CONTENTS

| | |
|------------------|---|
| FEATURES | 3 |
| KEY COMPONENTS | 5 |
| CONNECTION | 6 |
| COMPACT DESIGN | 6 |
| DESIGNATION KEY | 6 |
| PERFORMANCE DATA | 7 |
| HYDRONIC MODEL | 7 |
| OUTDOOR UNIT | 7 |

R32 ATW SPLIT TYPE

HEAT PUMP



5kW/8kW



10kW/12kW



14kW/16kW



8kW/12kW/16kW Hydronic module

FEATURES

MULTI APPLICATIONS IN ONE SYSTEM

- Includes hydronic module, no extra insulation of hot water pipes.
- Domestic hot water production all year round.
- Heating in winter and cooling in summer.
- Wide range of solutions: floor heating, radiators and fan coils.
- Great comfort at home even at low outdoor temperatures.
- Environmental friendly: using R32 refrigerant.

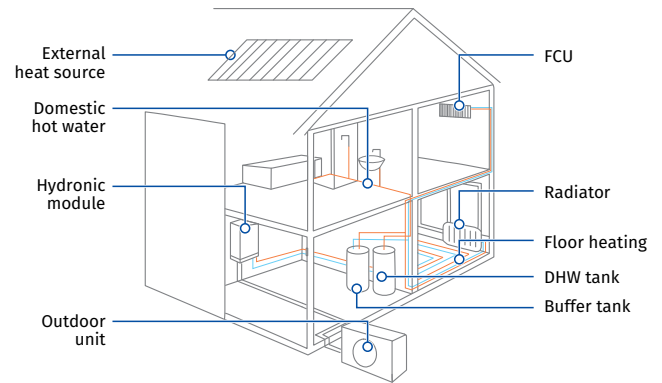

ECO FRIENDLY

- R32 (HFC-32) is a highly environmentally friendly refrigerant, with 0 ODP and 675 GWP, low carbon footprint, no harm to the Ozone.

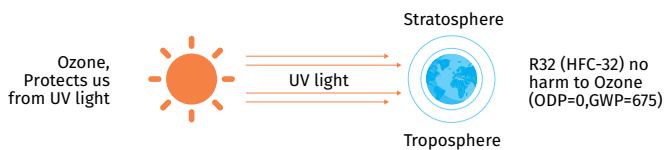

HIGH ENERGY EFFICIENCY

- ATW heat pumps are relying on renewable energy for their functioning, the increased use of renewable energy will also reduce our energy dependency.
- ErP directive:
 - ηs, Seasonal space heating energy efficiency
 - ηs average up to A++ @ 35°C
 - ηs average up to A++ @ 55°C

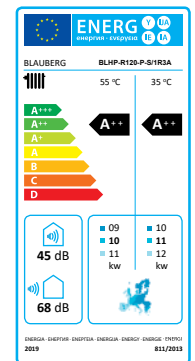

WIDE OPERATION RANGE

- Cooling operating temperature is up to 46 °C.
- Heating operating temperature is down to -28 °C.
- The max. water outlet temperature is up to 60 °C.

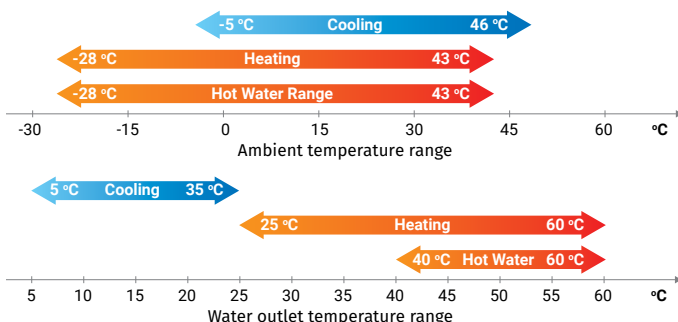

CAPTURE ENERGY FROM AMBIENT AIR

- Based on Air to Water heat pump technology, it captures heat energy from the ambient air and transfers it to heat the water that is used to warm your home and supply domestic hot water, it can even cool your home as required. Compared to other technologies, up to 75% of the heat energy required is taken from the ambient air.



R32 ATW SPLIT TYPE

HEAT PUMP

HYDRONIC MODULE COMPONENTS

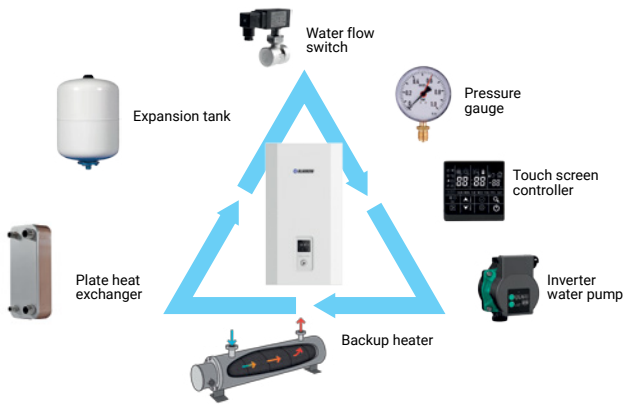

FULL CAPACITY IN LOW AMBIENT TEMPERATURE

- Thanks to the high compression ratio compressor, large heat exchanger and high-precision system control, it is able to maintain a high heat level and even at -10°C and -15°C.

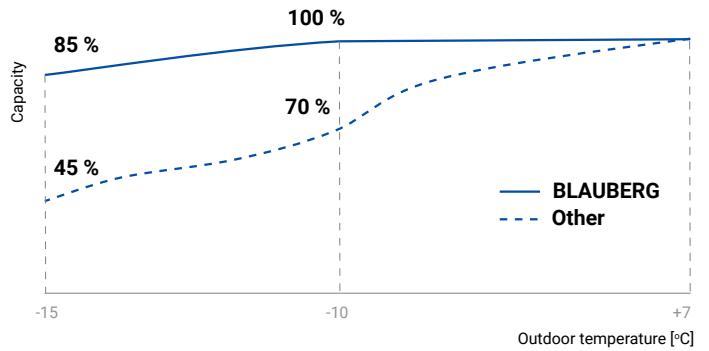

TOUCH SCREEN WIRED CONTROLLER

- Standard wired controller with touch screen, more functions can be realized and it is easier to operate.
- Wired controller can be disconnected from the hydronic module and installed in the room to detect room temperature.
- An additional cover is provided.



Built-in temperature sensor



Additional cover

WIRED CONTROLLER FUNCTIONS

- Window design, easy to operate & view.
- Mode control, temperature setting, heating mode, cooling mode, DHW mode, combined mode.
- Weekly timer function.
- Electric heater.
- Forced defrosting.
- Sterilization.
- Anti-freezing protection.
- WIFI control (optional).



HIGH EFFICIENCY AND FULL CAPACITY

Energy efficiency

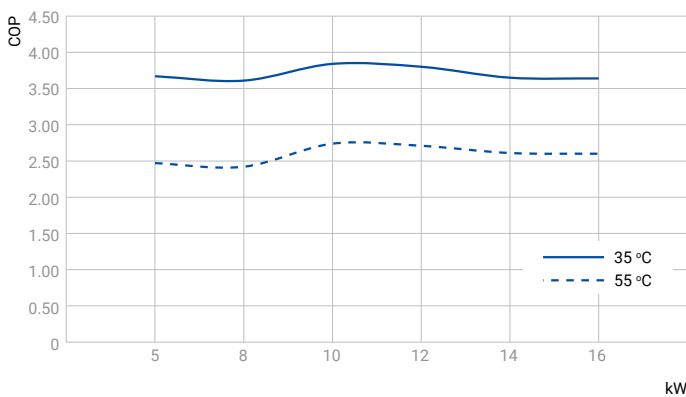

Heating capacity (16kW)

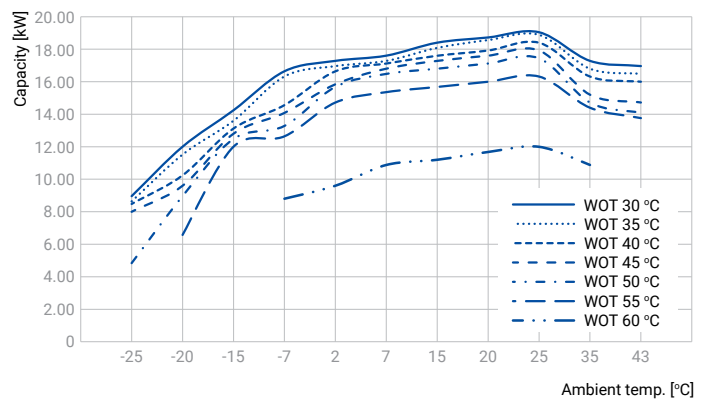

HOT WATER TEMPERATURE RANGE

- In cooling mode, the water outlet temperature range is 5-25 °C.
- In heating mode, the water outlet temperature range is 25-60 °C.
- In hot water mode, the water outlet temperature range is 40-60 °C.

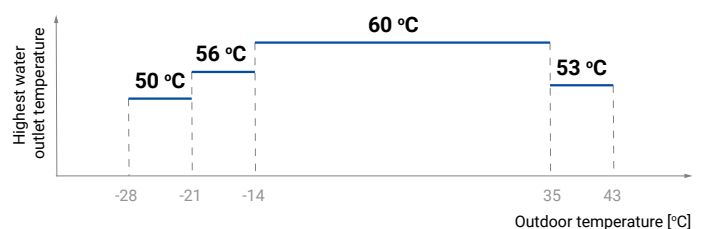

R32 ATW SPLIT TYPE

HEAT PUMP

KEY COMPONENTS

HIGH PRESSURE RATIO COMPRESSOR

- High pressure ratio compressor, the ratio is high to 13, which has better performance in low ambient temperature.
- Well know brand, GMCC.
- Rotary DC inverter compressor.
- Refrigerant: R32.



PLATE HEAT EXCHANGER

- Heat transfer is efficient for both heating and cooling use.
- With a small footprint.
- Can withstand high temperatures and high pressures.



DC FAN MOTOR

- DC brushless fan motor.
- Higher efficiency, lower noise.

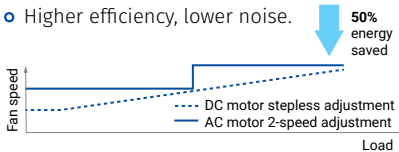

INVERTER WATER PUMP

- High efficiency inverter water pump.
- Water head is 9m for 8kW, 12kW and 16kW hydronic module.
- Compliance with CE and VDE.
- 50/60Hz.



BIGGER HEAT EXCHANGER

- Bigger heat exchanger, to meet the area of heat exchanging in low ambient temperature.
- Flat type fin, improve defrosting performance.

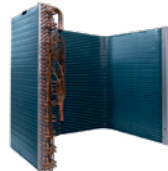

EXPANSION TANK

- As water is heated, it expands and its pressure increases if there's no room for thermal expansion, which will cause major issues with water system including failure or bursting.
- Expansion tank is used to keep the water system pressure stable.
- Pre pressure: 0.15MPa.
- Volume: 2L.



INTEGRATED PCB

- Integrated PCB for single phase unit, reduce the damage rate of each component.

Single phase unit



3-phase unit

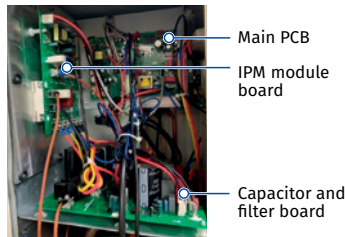

VALVES

- Water flow switch.
- When water flow is insufficient, the port is disconnected to shutdown the unit.
- Protect the hydronic module.
- Air purge valve.
- Installed in the highest place of the hydronic module.
- Safety valve.
- When the system pressure exceeds the specified value, the safety valve will be opened.
- Open pressure: 6bar (0.6MPa).



INSTRUCTION OF HYDRONIC MODULE

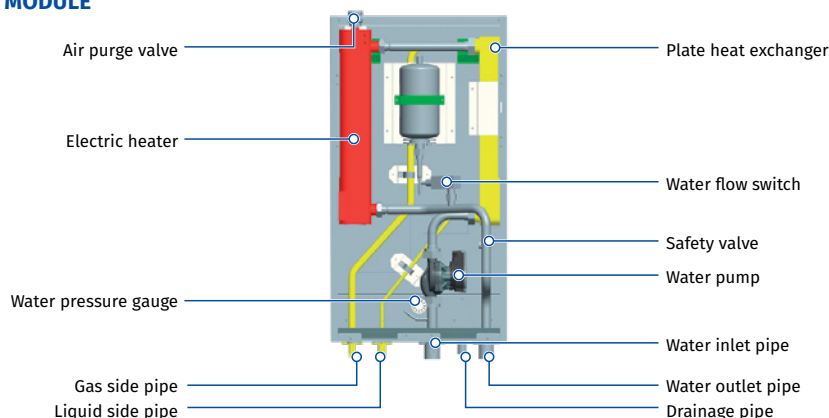

R32 ATW SPLIT TYPE HEAT PUMP

CONNECTION

SYSTEM CONNECTION

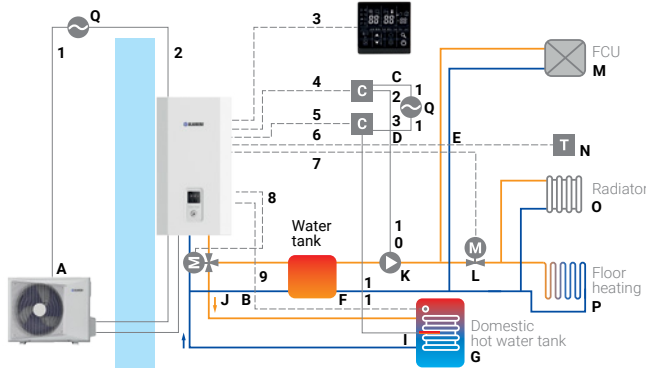

ACCESSORY CONNECTION

- Connect to a room thermostat.
- Connect to 2-way valve and 3-way valve, to change the water flow direction. Connect to the booster heater to control the heater in the DHW tank.
- Connect to additional circulation water pump.
- Alarm output.

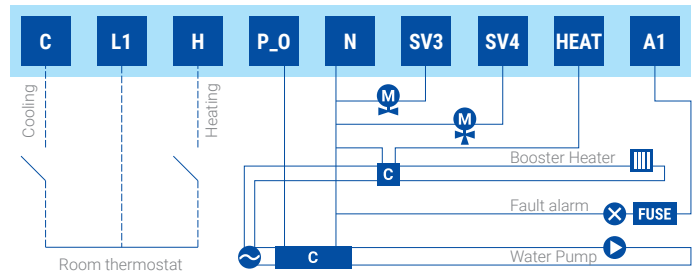

COMPACT DESIGN



| Model | A [mm] | L [mm] | H [mm] |
|-------------------------|--------|--------|--------|
| 5kW & 8kW (1Ph) | 935 | 383 | 702 |
| 10kW & 12kW (1Ph) | 1032 | 445 | 810 |
| 14kW & 16kW (3Ph) | 1014 | 450 | 1430 |
| 8kW & 12kW & 16kW (1Ph) | 490 | 340 | 910 |

DESIGNATION KEY

| Brand name | Name of the unit | Compressor type | Rated capacity | Heat exchanger | The unit | Power supply | Refrigerant unit | Generation |
|------------|------------------|------------------------|--|-----------------------------|--|--|----------------------------------|-------------------|
| BLAUBERG | BLHP | R: rotary S: scroll | 040, 050, 060, 080, 100, 120, 140, 160 | P: plate S: shell & tybe | S: split unit M: monoblock unit A: all-in-one unit | 3 - 380-415V/3ph/50Hz 1 - 220-240V/1ph/50Hz | R3: R32 R2: R290 R1: R410A | A: 1st generation |

R32 ATW SPLIT TYPE

HEAT PUMP

PERFORMANCE DATA

| Outdoor Unit Indoor Unit | BLHP-R050-P-S/1R3A | BLHP-R080-P-S/1R3A | BLHP-R100-P-S/1R3A | BLHP-R120-P-S/1R3A | BLHP-R140-P-S/3R3A | BLHP-R160-P-S/3R3A |
|--|--------------------|--------------------|--------------------|--------------------|--------------------|--------------------|
| Heating Capacity/COP (A7°C/W35°C) [kW/COP] | 5.29/3.67 | 8.26/3.61 | 10.8/3.84 | 12.84/3.80 | 15.26/3.65 | 17.28/3.64 |
| Heating Capacity/COP (A7°C/W55°C) [kW/COP] | 3.90/2.47 | 6.14/2.42 | 9.6/2.74 | 11.4/2.71 | 13.58/2.61 | 15.36/2.6 |
| Heating Capacity/COP (A-7°C/W35°C) [kW/COP] | 5.15/3.34 | 8.04/3.29 | 10.2/2.88 | 12.12/2.85 | 14.42/2.74 | 16.32/2.73 |
| Heating Capacity/COP (A-7°C/W55°C) [kW/COP] | 3.95/2.17 | 6.20/2.13 | 7.11/1.73 | 8.42/1.70 | 11.2/1.83 | 12.64/1.82 |
| Heating Capacity/COP (A-15°C/W35°C) [kW/COP] | 4.38/2.39 | 6.83/2.36 | 8.5/2.41 | 10.2/2.41 | 12.04/2.3 | 13.6/2.9 |
| Heating Capacity/COP (A-15°C/W55°C) [kW/COP] | 2.86/1.79 | 4.49/1.76 | 6.75/1.63 | 7.99/1.61 | 10.64/1.73 | 12/1.72 |
| Cooling Capacity/EER (A35°C/W7°C) [kW/EER] | 4.5/2.7 | 6.5/2.8 | 8.5/2.8 | 10/2.7 | 13.8/2.82 | 15.2/2.81 |
| Cooling Capacity/EER (A35°C/W18°C) [kW/EER] | 4.2/3.8 | 6.5/3.8 | 8.5/4.8 | 10/4.8 | 13.8/4.8 | 15.2/4.8 |
| Seasonal Energy Efficiency (W35°C/W55°C) Heating Average Climate [SCOP(kW)] | 4.73/3.29 | 4.42/3.24 | 5.15/3.35 | 4.34/3.33 | 4.08/3.33 | 4.07/3.38 |
| Seasonal Energy Efficiency (W35°C/W55°C) Heating Average Climate [ETA(%)] | 189.14/131.65 | 176.8/129.6 | 203/131.1 | 170.6/130.2 | 160.2/130.2 | 159.7/132.1 |
| Seasonal Space Heating Energy eff.Class (Average Climate General) Water Outlet [35°C] | A++ | A++ | A++ | A++ | A++ | A++ |
| Seasonal Space Heating Energy eff.Class (Average Climate General) Water Outlet [55°C] | A++ | A++ | A++ | A++ | A++ | A++ |

HYDRONIC MODEL

| Indoor Unit | BLHP-R050-P-S/1R3A | BLHP-R080-P-S/1R3A | BLHP-R100-P-S/1R3A | BLHP-R120-P-S/1R3A | BLHP-R140-P-S/3R3A | BLHP-R160-P-S/3R3A |
|--|--------------------|--------------------|--------------------|--------------------|--------------------|--------------------|
| Hydronic Model [V/N/Hz] | 220-240/1/50 | 220-240/1/50 | 220-240/1/50 | 220-240/1/50 | 220-240/1/50 | 220-240/1/50 |
| Sound Power Level [dB(A)] | 45 | 45 | 45 | 45 | 45 | 45 |
| Dimension (WxHxD) [mm] | 490x910x340 | 490x910x340 | 490x910x340 | 490x910x340 | 490x910x340 | 490x910x340 |
| Packing (WxHxD) [mm] | 620x1105x425 | 620x1105x425 | 620x1105x425 | 620x1105x425 | 620x1105x425 | 620x1105x425 |
| Net/Gross Weight [kg] | 47/55 | 47/55 | 48/56 | 48/56 | 48/56 | 48/56 |
| Water Pipe Connector (Inlet/Outlet) [mm] | DN32/DN32 | DN32/DN32 | DN32/DN32 | DN32/DN32 | DN32/DN32 | DN32/DN32 |
| Water Pump | Variable Speed | Variable Speed | Variable Speed | Variable Speed | Variable Speed | Variable Speed |
| Capacity of Electric Heater [kW] | 3 | 3 | 3 | 3 | 3 | 3 |
| Max. power Input [kW] | 3.6 | 3.6 | 3.6 | 3.6 | 3.6 | 3.6 |
| Max. current Input [A] | 17 | 17 | 17 | 17 | 17 | 17 |

OUTDOOR UNIT

| Outdoor Unit | BLHP-R050-P-S/1R3A | BLHP-R080-P-S/1R3A | BLHP-R100-P-S/1R3A | BLHP-R120-P-S/1R3A | BLHP-R140-P-S/3R3A | BLHP-R160-P-S/3R3A | |
|--|-------------------------|-----------------------------------|--------------------|--------------------|--------------------|--------------------|---------|
| Hydronic Model [V/N/Hz] | 220-240/1/50 | 220-240/1/50 | 220-240/1/50 | 220-240/1/50 | 380-415/3/50 | 380-415/3/50 | |
| Sound Power Level [dB(A)] | 64 | 66 | 68 | 68 | 70 | 70 | |
| Max. power Input [kW] | 2.86 | 4.2 | 5.0 | 5.0 | 5.5 | 6.4 | |
| Max. current Input [A] | 13 | 19 | 22 | 22 | 10.5 | 12.1 | |
| Dimension (WxHxD) [mm] | 935x702x382 | 935x702x382 | 1032x810x445 | 1032x810x445 | 1014x1430x450 | 1014x1430x450 | |
| Packing (WxHxD) [mm] | 975x770x435 | 975x770x435 | 1075x875x495 | 1075x875x495 | 1095x1545x485 | 1095x1545x485 | |
| Net/Gross Weight [kg] | 47/51 | 55/58 | 56.3/61 | 63.5/68 | 124/138 | 124/138 | |
| Air Flow [m³/h] | 3200 | 3200 | 4000 | 4000 | 6100 | 6100 | |
| Pipe Diameter [mm] | 9.52/15.88 | 9.52/15.88 | 9.52/15.88 | 9.52/15.88 | 9.52/15.88 | 9.52/15.88 | |
| Max. piping Length/Height Difference [m] | 20/10 | 20/10 | 20/10 | 50/20 | 50/20 | 50/20 | |
| Refrigerant | Type/Quantity [kg] | R32/1.1 | R32/1.4 | R32/3.0 | R32/3.1 | R32/3.6 | R32/3.8 |
| | Additional Charge [g] | (Total Pipe Length [m] - 5)*30g/m | | | | | |
| Ambient Temperature Range | Cooling [°C] | | | | | -5...46 | |
| | Heating [°C] | | | | | -28...43 | |
| | Domestic Hot Water [°C] | | | | | -28...43 | |
| Water Temperature Range | Cooling [°C] | | | | | 5...25 | |
| | Heating [°C] | | | | | 25...60 | |
| | Domestic Hot Water [°C] | | | | | 40...60 | |

- 1 Integrated value takes into consideration the capacity drop during frosting and defrosting periods. The capacity is tested in a free frequency situation.
- 2 The above data may be changed without notice for future improvement in quality and performance.

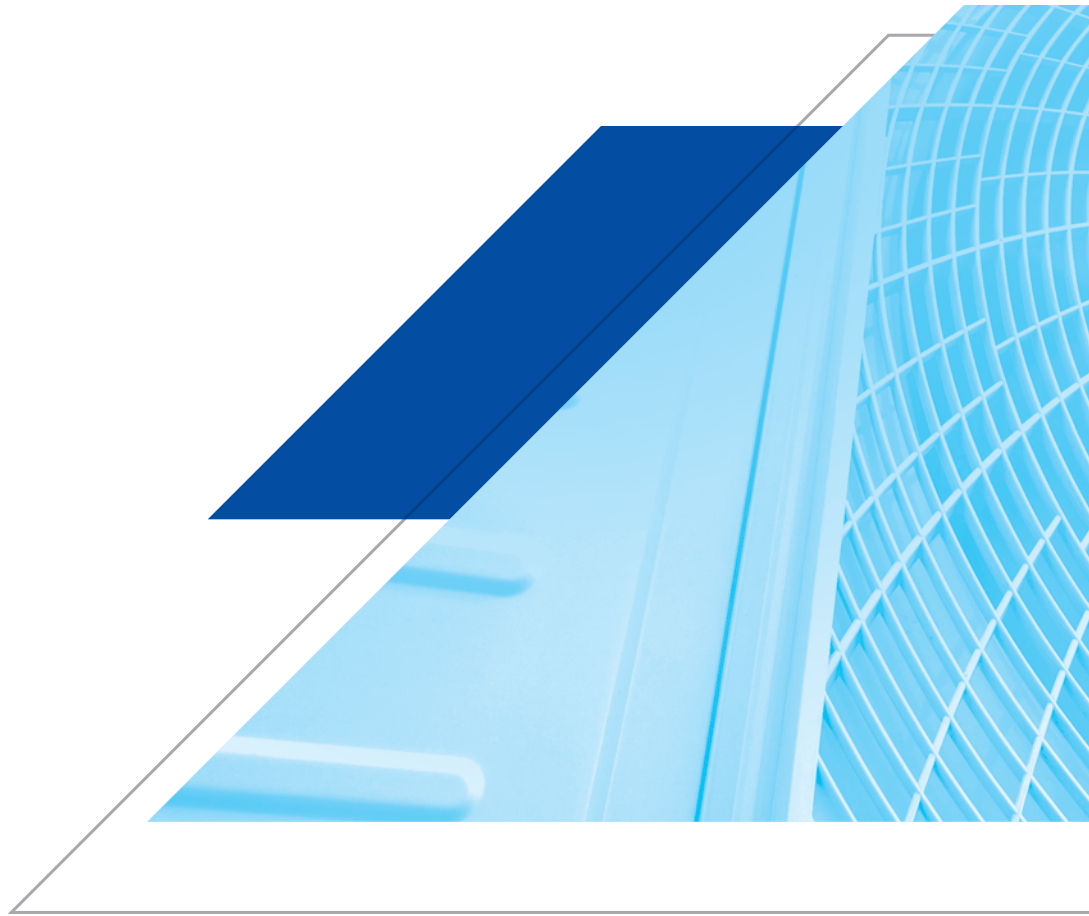

Blauberg Ventilatoren GmbH
Aidenbachstr. 52
D-81379 Munich

info@blaubergventilatoren.de
www.blaubergventilatoren.de

Technical changes reserved.
Illustrations and texts are non-binding.

04/2023